

Practical Guide for the Diagnosis and Management of Asthma

Based on the *Expert Panel Report 2:
Guidelines for the Diagnosis and
Management of Asthma*

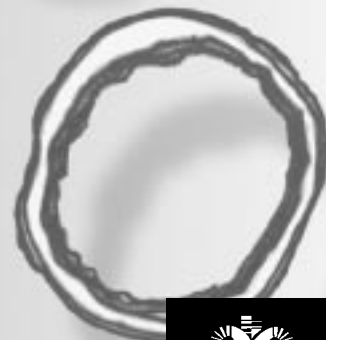

Second Expert Panel on the Management of Asthma

*Shirley Murphy, M.D., *Chair*
University of New Mexico

Eugene R. Bleecker, M.D.
University of Maryland

*Homer Boushey, M.D.
University of California at San Francisco

*A. Sonia Buist, M.D.
Oregon Health Sciences University

*William Busse, M.D.
University of Wisconsin

Noreen M. Clark, Ph.D.
University of Michigan

Howard Eigen, M.D.
Riley Hospital for Children

Jean G. Ford, M.D.
Columbia University

*Susan Janson, D.N.Sc., R.N.
University of California, San Francisco

*H. William Kelly, Pharm.D.
University of New Mexico

Robert F. Lemanske, Jr., M.D.
University of Wisconsin

Carolyn C. Lopez, M.D.
Rush Medical College

Fernando Martinez, M.D.
University of Arizona

*Harold S. Nelson, M.D.
National Jewish Medical and Research
Center

Richard Nowak, M.D., M.B.A.
Henry Ford Hospital

Thomas A.E. Platts-Mills, M.D., Ph.D.
University of Virginia

Gail G. Shapiro, M.D.
University of Washington

Stuart Stoloff, M.D.
Private Family Practice
and
University of Nevada

Kevin Weiss, M.D., M.P.H.
Rush Primary Care Institute

Federal Liaison Representatives

Clive Brown, M.B.B.S., M.P.H.
Centers for Disease Control and Prevention

Peter J. Gergen, M.D.
(formerly with the National Institute of
Allergy and Infectious Diseases)
Agency for Health Care Policy and Research

Edward L. Petsonk, M.D.
National Institute for Occupational Safety
and Health

National Heart, Lung, and Blood Institute Staff

Ted Buxton, M.P.H.
Robinson Fulwood, M.S.P.H.
Michele Hindi-Alexander, Ph.D.
Suzanne S. Hurd, Ph.D.
Virginia S. Taggart, M.P.H.

R.O.W. Sciences, Inc., Support Staff

Ruth Clark
Daria Donaldson
Lisa Marcellino
Donna Selig
Keith Stanger
Eileen Zeller, M.P.H.

* Executive Committee Member

National Asthma Education and Prevention Program Coordinating Committee Organizations

Allergy and Asthma Network/Mothers of
Asthmatics, Inc.
American Academy of Allergy, Asthma,
and Immunology
American Academy of Family
Physicians
American Academy of Pediatrics
American Academy of Physician
Assistants
American Association for
Respiratory Care
American Association of
Occupational Health Nurses
American College of Allergy, Asthma,
and Immunology
American College of Chest Physicians
American College of Emergency
Physicians

American Lung Association
American Medical Association
American Nurses Association, Inc.
American Pharmaceutical Association
American Public Health Association
American School Health Association
American Society of Health-System
Pharmacists
American Thoracic Society
Association of State and Territorial
Directors of Health Promotion and
Public Health Education
Asthma and Allergy Foundation of
America
Centers for Disease Control and
Prevention
National Association of School Nurses
National Black Nurses Association, Inc.

National Center for Environmental
Health
National Center for Health Statistics
NHLBI Ad Hoc Committee on
Minority Populations
National Heart, Lung, and Blood
Institute
National Institute for Occupational
Safety and Health
National Institute of Allergy and
Infectious Diseases
National Institute of Environmental
Health Sciences
National Medical Association
Society for Public Health Education
U.S. Environmental Protection Agency
U.S. Food and Drug Administration
U.S. Public Health Service

Practical Guide for the Diagnosis and Management of Asthma

Based on the *Expert Panel Report 2:
Guidelines for the Diagnosis and
Management of Asthma*

U.S. DEPARTMENT OF HEALTH
AND HUMAN SERVICES
PUBLIC HEALTH SERVICE
NATIONAL INSTITUTES OF HEALTH
National Heart, Lung,
and Blood Institute

NIH PUBLICATION No. 97-4053

OCTOBER 1997

Contents

Introduction	1
Practical and Effective Asthma Care	1
Asthma Care in the United States Can Be Improved	1
Airway Inflammation Plays a Central Role in Asthma and Its Management	1
Asthma Changes Over Time, Requiring Active Management	2
Four Key Components for Long-Term Control of Asthma	2
References	2
Major Recommendations From the <i>Expert Panel Report 2: Guidelines for the Diagnosis and Management of Asthma</i>	3

Figure 1. Mechanisms Underlying the Definition of Asthma	2
--	---

Figure 2. Asthma Changes Over Time: Patient Monitoring and Followup Required	2
--	---

1. Initial Assessment and Diagnosis of Asthma	4
Diagnosis of Asthma in Adults and Children Over 5 Years of Age	4
Diagnosis in Infants and Children Younger Than 5 Years of Age	5
Additional Tests for Adults and Children	5
Patient Education After Diagnosis	6
Assessment of Asthma Severity	6
General Guidelines for Referral to an Asthma Specialist	6

2. Pharmacologic Therapy: Managing Asthma Long Term	7
Establish the Goals of Asthma Therapy With the Patient	7
The Asthma Medications: Long-Term Control and Quick Relief	7
Inhaled Steroids: The Most Effective Long-Term-Control Medication for Asthma	8
Stepwise Approach to Managing Asthma in Adults and in Children Over 5 Years of Age	9
Gaining Control of Asthma	9
Maintaining Control	9
Step Down Therapy	9
Step Up Therapy	10
Special Considerations for Infants, Children, and Adolescents	10
Infants and Preschool Children	10
School-Age Children and Adolescents	14
Inhaled Steroids and Growth	14
Action Plan for Schools	14
Managing Asthma in Older Adults	14
Managing Special Situations	15
Managing Exercise-Induced Bronchospasm	15
Managing Seasonal Asthma Symptoms	15
Managing Asthma in Patients Undergoing Surgery	16
Managing Asthma in Pregnant Women	16

	Figure 3. Classification of Asthma Severity: Clinical Features Before Treatment	10
	Figure 4. Stepwise Approach for Managing Asthma in Adults and Children Over 5 Years Old: Treatment	11
	Figure 5. Stepwise Approach for Managing Infants and Young Children (5 Years of Age and Younger) With Acute or Chronic Asthma Symptoms	12
	Figure 6. Indicators of Poor Asthma Control—Consider Increasing Long-Term Medications	13
	Figure 7. Assess Reasons for Poor Asthma Control Before Increasing Medications—ICE	13
<hr/>		
3.	Control of Factors Contributing to Asthma Severity	17
	Patient Assessment and Education	17
	Inhaled Allergens and Persistent Asthma	17
	Allergy Testing	18
	Control Measures for Factors Contributing to Asthma Severity	19
	Immunotherapy	19
	Figure 8. Allergen Control Significantly Improves Even Mild Asthma: An Illustrative Study with House-Dust Mites	17
	Figure 9. Determining the Need for Allergen Control in Patients With Persistent Asthma	18
<hr/>		
4.	Periodic Assessment and Monitoring	20
	Working Within the Time Constraints of the Typical Office Visit	20
	Patient Self-Monitoring	21
	Clinician Assessment	22
	Identify Patient Concerns and Expectations of the Visit	22
	Assess Achievement of the Goals of Asthma Therapy	22
	Review Medications Usage and Skills	22
<hr/>		
5.	Education for a Partnership in Asthma Care	23
	How To Increase the Likelihood of Compliance	23
	Teach Use of Inhaler and Peak Flow Meter	25
	Tips for Replacing Metered-Dose Inhalers	25
	Figure 10. Example of Delivery of Asthma Education by Clinicians During Patient Care Visits	24
	Figure 11. How Often To Change Long-Term-Control Canisters	25

6.	Managing Asthma Exacerbations at Home, in the Emergency Department, and in the Hospital	26
	Home Management: Prompt Treatment Is Key	26
	Risk Factors for Death From Asthma	26
	Prehospital Emergency Medicine/Ambulance Management	28
	Emergency Department and Hospital Management of Exacerbations	28
	Treat Without Delay	28
	Repeat Assessment	28
	Special Considerations for Infants	30
	Therapies Not Recommended for Treating Exacerbations	30
	Hospital Asthma Care	30
	Patient Discharge From the Emergency Department or Hospital	30
	Figure 12. Management of Asthma Exacerbations: Home Treatment	27
	Figure 13. Management of Asthma Exacerbations: Emergency Department and Hospital-Based Care	29
	References	32

Appendices

Dosages for Medications

Usual Dosages for Long-Term-Control Medications	36
Estimated Comparative Daily Dosages for Inhaled Steroids	38
Dosages of Drugs for Asthma Exacerbations in Emergency Medical Care or Hospital	39

Glossary

Asthma Long-Term-Control Medications	40
Asthma Quick-Relief Medications	40

Patient Handouts

What Everyone Should Know About Asthma Control	41
How To Control Things That Make Your Asthma Worse	42
How To Use Your Metered-Dose Inhaler the Right Way	44
Asthma Action Plan	45
School Self-Management Plan	46
How To Use Your Peak Flow Meter	48

Patient Self-Assessment Forms

Patient Self-Assessment Form for Environmental and Other Factors That Can Make Asthma Worse	50
Patient Self-Assessment Form for Followup Visits	52

Introduction

Practical and Effective Asthma Care

This Practical Guide for the Diagnosis and Management of Asthma describes how primary care clinicians can improve the asthma care they provide within the time constraints of their current clinical practice. More than 130 primary care professionals reviewed this guide to help assure that it is relevant and practical for primary care practitioners.

The recommendations in the Practical Guide are summarized from the National Asthma Education and Prevention Program, *Expert Panel Report 2: Guidelines for the Diagnosis and Management of Asthma* (EPR-2).¹ See page 3 for a summary of some major recommendations from EPR-2.

Asthma Care in the United States Can Be Improved

Undertreatment and inappropriate therapy are major contributors to asthma morbidity and mortality in the United States. A few examples of data that support this assertion are presented below.

- Hospitalizations due to asthma are preventable or avoidable when patients receive appropriate primary care.²
 - Asthma is the third leading cause of preventable hospitalizations in the United States.²
 - There are about 470,000 hospitalizations and more than 5,000 deaths a year from asthma.

- Studies from two metropolitan areas of children with asthma who used the emergency department³ and adults hospitalized with asthma⁴ found that:
 - Less than half of these patients were receiving anti-inflammatory therapy as recommended in the EPR-2.¹
 - Only 28 percent of the adult patients hospitalized for asthma had written action plans that told how to manage their asthma and control an exacerbation.⁴

The Practical Guide will help clinicians improve the asthma care they provide and reduce the hospitalizations and emergency department visits needed by their patients.

Airway Inflammation Plays a Central Role in Asthma and Its Management

The management of asthma needs to be responsive to the characteristics that define asthma. The relationships between these characteristics are illustrated in figure 1.

- **Asthma is a chronic inflammatory disorder of the airways.** Many cells and cellular elements play a role, in particular, mast cells, eosinophils, T-lymphocytes, macrophages, neutrophils, and epithelial cells.
- **Environmental and other factors “cause” or provoke the airway inflammation in people with asthma.** Examples of these factors include inhaled allergens to which the patient is sensitive, some irritants, and viruses. This inflammation is always present to some degree, regardless of the level of asthma severity.

Figure 1.

Mechanisms Underlying the Definition of Asthma

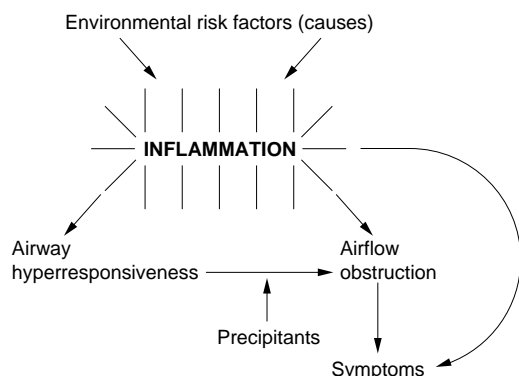

Adapted with permission from Stephen T. Holgate, M.D., D.Sc.

Figure 2.

Asthma Changes Over Time: Patient Monitoring and Followup Required

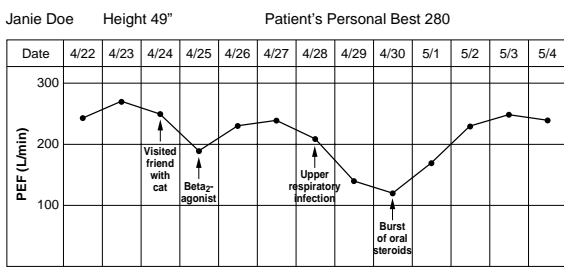

- **Airway inflammation causes recurrent episodes** in asthma patients of wheezing, breathlessness, chest tightness, and coughing, particularly at night and in the early morning.
- These episodes of asthma symptoms are usually associated with widespread but **variable airflow obstruction that is often reversible** either spontaneously or with treatment. Airflow obstruction is caused by a variety of changes in the airway, including bronchoconstriction, airway edema, chronic mucus plug formation, and airway remodeling.
- **Inflammation causes an associated increase in the existing airway hyperresponsiveness** to a variety of stimuli, such as allergens, irritants, cold air, and viruses. These stimuli or **precipitants result in airflow obstruction** and asthma symptoms in the patient with asthma.

Asthma Changes Over Time, Requiring Active Management

The condition of a patient’s asthma will change depending on the environment, patient activities, management practices, and other factors (see figure 2). Thus, even when patients have their asthma under control, monitoring and treatment are needed to maintain control.

Four Key Components for Long-Term Control of Asthma

The four components of asthma therapy respond to the basic nature of asthma described previously. The four components are listed below and will be described in this guide.

- Assessment and monitoring
- Pharmacologic therapy
- Control of factors contributing to asthma severity
- Patient education for a partnership

References

In EPR-2, the Expert Panel cites the scientific literature to support its recommendations or clearly indicates they are “based on the opinion of the Expert Panel.” The Panel submitted multiple drafts of EPR-2 for review by more than 140 outside reviewers, including members of the NAEPP Coordinating Committee. This Practical Guide summarizes the recommendations in EPR-2, provides practical information to aid the implementation of those recommendations, and cites selected references from EPR-2. For complete documentation of the recommendations, refer to EPR-2. Copies of the full report can be accessed through the Internet (<http://www.nhlbi.nih.gov/nhlbi/lung/asthma/prof/asthgdln.htm>) or purchased from the NHLBI Information Center, P.O. Box 30105, Bethesda, MD 20824-0105 (phone 301-251-1222; fax 301-251-1223).

This guide presents basic recommendations for the diagnosis and management of asthma that will help clinicians and patients make appropriate decisions about asthma care. Of course, the clinician and patient need to develop an individual treatment plan that is tailored to the specific needs of the patient. This report is not an official regulatory document of any Government agency.

Major Recommendations From the *Expert Panel Report 2: Guidelines for the Diagnosis and Management of Asthma*¹

Diagnose asthma and initiate partnership with patient.

- **Diagnose asthma** by establishing:
 - A history of recurrent symptoms,
 - Reversible airflow obstruction using spirometry, and
 - The exclusion of alternative diagnoses.
- **Establish patient-clinician partnership.**
 - Address patient's concerns.
 - Agree upon the goals of asthma therapy.
 - Agree upon a written action plan for patient self-management.

Reduce inflammation, symptoms, and exacerbations.

- **Prescribe anti-inflammatory medications to patients with mild, moderate, or severe persistent asthma** (i.e., inhaled steroids, cromolyn, or nedocromil).
- **Reduce exposures to precipitants of asthma symptoms.**
 - Assess patient's exposure and sensitivity to individual precipitants (e.g., allergens, irritants).
 - Provide written and verbal instructions on how to avoid or reduce factors that make the patient's asthma worse.

Monitor and manage asthma over time.

- **Train all patients to monitor their asthma.**
 - All patients should monitor symptoms.
 - Patients with moderate-to-severe persistent asthma should also monitor their peak flow.
- **See patients at least every 1 to 6 months**
 - Assess attainment of goals of asthma therapy and patient's concerns,
 - Adjust treatment, if needed,
 - Review the action plan with patient, and
 - Check patient's inhaler and peak flow technique.

Treat asthma episodes promptly.

- Prompt use of short-acting inhaled beta₂-agonists and, if episode is moderate to severe, a 3- to 10-day course of oral steroids.
- Prompt communication and followup with clinician.

- ▶ Assessment and monitoring
- ▶ Pharmacologic therapy
- ▶ Control of factors contributing to asthma severity
- ▶ Patient education for a partnership

1 Initial Assessment and Diagnosis of Asthma

Diagnosis of Asthma in Adults and Children Over 5 Years of Age

Recurrent episodes of coughing or wheezing are almost always due to asthma in both children and adults. Cough can be the sole symptom.

Findings that increase the probability of asthma include:

Medical history:

- Episodic wheeze, chest tightness, shortness of breath, or cough.
- Symptoms worsen in presence of aeroallergens, irritants, or exercise.
- Symptoms occur or worsen at night, awakening the patient.
- Patient has allergic rhinitis or atopic dermatitis.
- Close relatives have asthma, allergy, sinusitis, or rhinitis.

Physical examination of the upper respiratory tract, chest, and skin:

- Hyperexpansion of the thorax
- Sounds of wheezing during normal breathing or a prolonged phase of forced exhalation
- Increased nasal secretions, mucosal swelling, sinusitis, rhinitis, or nasal polyps
- Atopic dermatitis/eczema or other signs of allergic skin problems

To establish an asthma diagnosis, determine the following:

- 1. History or presence of episodic symptoms of airflow obstruction** (i.e., wheeze, shortness of breath, tightness in the chest, or cough). Asthma symptoms vary throughout the day; absence of symptoms at the time of the examination does not exclude the diagnosis of asthma.
- 2. Airflow obstruction is at least partially reversible.** Use spirometry to:

Establish airflow obstruction: $FEV_1 < 80$ percent predicted; $FEV_1/FVC^* < 65$ percent or below the lower limit of normal. (If obstruction is absent, see Additional Tests, page 5.)

Establish reversibility: FEV_1 increases ≥ 12 percent and at least 200 mL after using a short-acting inhaled β_2 -agonist (e.g., albuterol, terbutaline).

NOTE: Older adults may need to take oral steroids for 2 to 3 weeks and then take the spirometry test to measure the degree of reversibility achieved. Chronic bronchitis and emphysema may coexist with asthma in adults. The degree of reversibility indicates the degree to which asthma therapy may be beneficial.

- 3. Alternative diagnoses are excluded** (e.g., vocal cord dysfunction, vascular rings, foreign bodies, or other pulmonary diseases). See page 5 for additional tests that may be needed.

In general, FEV_1 predicted norms or reference values used for children should also be used for adolescents.

* FEV_1 , forced expiratory volume in 1 second
FVC, forced vital capacity

Diagnosis in Infants and Children Younger Than 5 Years of Age

Because children with asthma are often mislabeled as having bronchiolitis, bronchitis, or pneumonia, many do not receive adequate therapy.

- The diagnostic steps listed previously are the same for this age group except that spirometry is not possible. A trial of asthma medications may aid in the eventual diagnosis.

- **Diagnosis is not needed to *begin* to treat wheezing associated with an upper respiratory viral infection, which is the most common precipitant of wheezing in this age group.** Patients should be monitored carefully.
- There are two general patterns of illness in infants and children who have wheezing with acute viral upper respiratory infections: a remission of symptoms in the preschool years and persistence of asthma throughout childhood. The factors associated with continuing asthma are allergies, a family history of asthma, and perinatal exposure to aeroallergens and passive smoke.

Additional Tests for Adults and Children

Additional tests may be needed when asthma is suspected but spirometry is normal, when coexisting conditions are suspected, or for other reasons.

These tests can aid diagnosis or confirm suspected contributors to asthma morbidity (e.g., allergens and irritants).

Reasons for Additional Tests

The Tests

- Patient has symptoms but spirometry is normal or near normal

- Assess diurnal variation of peak flow over 1 to 2 weeks.

- Refer to a specialist for bronchoprovocation with methacholine, histamine, or exercise; negative test may help rule out asthma.

- Suspect infection, large airway lesions, heart disease, or obstruction by foreign object

- Chest x-ray

- Suspect coexisting chronic obstructive pulmonary disease, restrictive defect, or central airway obstruction

- Additional pulmonary function studies
- Diffusing capacity test

- Suspect other factors contribute to asthma (These are not diagnostic tests for asthma.)

- Allergy tests—skin or in vitro
- Nasal examination
- Gastroesophageal reflux assessment

Patient Education After Diagnosis

Identify the concerns the patient has about being diagnosed with asthma by asking: “What worries you most about having asthma? What concerns do you have about your asthma?”

Address the patient’s concerns and make at least these key points (see patient handout, “What Everyone Should Know About Asthma Control”):

- **Asthma can be managed and the patient can live a normal life.**
- **Asthma can be controlled when the patient works together with the medical staff.** The patient plays a big role in monitoring asthma, taking medications, and avoiding things that can cause asthma episodes.
- **Asthma is a chronic lung disease characterized by inflammation of the airways.** There may be periods when there are no symptoms, but the airways are swollen and sensitive to some degree all of the time. Long-term anti-inflammatory medications are important to control airway inflammation.
- **Many things in the home, school, work, or elsewhere can cause asthma attacks** (e.g., secondhand tobacco smoke, allergens, irritants). An asthma attack (also called episodes, flareups, or exacerbations) occurs when airways narrow, making it harder to breathe.
- **Asthma requires long-term care and monitoring.** Asthma cannot be cured, but it can be controlled. Asthma can get better or worse over time and requires treatment changes.

Patient education should begin at the time of diagnosis and continue at every visit.

Assessment of Asthma Severity

See figure 3 on page 10 to estimate the severity of chronic asthma in patients of all age groups. These levels of severity correspond to the “steps” of pharmacologic therapy discussed later.

General Guidelines for Referral to an Asthma Specialist

Based on the opinion of the Expert Panel, referral for consultation or care to a specialist in asthma care is recommended if assistance is needed for:

- **Diagnosis and assessment** (e.g., differential diagnosis is problematic, other conditions aggravate asthma, or confirmation is needed on the contribution of occupational or environmental exposures)
- **Specialized treatment and education** (e.g., considering patient for immunotherapy or providing additional education for allergen avoidance)
- **Other cases:**
 - Patient is not meeting the goals of asthma therapy (defined in next section) after 3 to 6 months. An earlier referral or consultation is appropriate if the physician concludes that the patient is unresponsive to therapy.
 - Life-threatening asthma exacerbation occurred.
 - Patient requires step 4 care (see figure 4 on page 11) or has used more than two bursts of oral steroids in 1 year. (Referral may be considered for patients requiring step 3 care.)
 - Patient is younger than age 3 and requires step 3 or 4 care. Referral should be considered for patients under age 3 who require step 2 care (see figure 5 on page 12).

An asthma specialist is usually a fellowship-trained allergist or pulmonologist or, occasionally, a physician with expertise in asthma management developed through additional training and experience.

Patients with significant psychiatric, psychosocial, or family problems that interfere with their asthma therapy should be referred to an appropriate mental health professional for counseling or treatment.

Assessment and monitoring
▶ Pharmacologic therapy
Control of factors contributing to asthma severity
▶ Patient education for a partnership

2 Pharmacologic Therapy: Managing Asthma Long Term

Establish the Goals of Asthma Therapy With the Patient

The goals of asthma therapy provide the criteria that the clinician and patient will use to evaluate the patient’s response to therapy. The goals will provide the focus for all subsequent interactions with the patient.

First, determine the patient’s personal goals of therapy by asking a few questions, such as: “What would you like to be able to do that you can’t do now or can’t do well because of your asthma?” “What would you like to accomplish with your asthma treatment?”

Then, share the general goals of asthma therapy with the patient and the family.

Finally, agree on the goals you and the patient will set as the foundation for the patient’s treatment plan.

General Goals of Asthma Therapy

- **Prevent chronic asthma symptoms and asthma exacerbations during the day and night.** (Indicators: No sleep disruption by asthma. No missed school or work due to asthma. No or minimal need for emergency department visits or hospitalizations.)
- **Maintain normal activity levels**—including exercise and other physical activities.
- **Have normal or near-normal lung function.**
- **Be satisfied with the asthma care received.**
- **Have no or minimal side effects** while receiving optimal medications.

The Asthma Medications: Long-Term Control and Quick Relief

■ **Long-term-control asthma medications are taken daily to achieve and maintain control of persistent asthma** (for dosage information, see pages 36-38). The most effective long-term-control medications for asthma are those that reduce inflammation. Inhaled steroids are the most potent inhaled anti-inflammatory medication currently available (see next page).

Inhaled steroids are generally well tolerated and safe at recommended doses. To reduce the potential for adverse effects, **patients taking inhaled steroids should:**

- Use a spacer/holding chamber.
- Rinse and spit following inhalation.
- Use the lowest possible dose to maintain control. Consider adding a long-acting inhaled beta₂-agonist to a low-to-medium dose of inhaled steroid rather than using a higher dose of inhaled steroid.^{17,18}

■ **Quick-relief medications are used to provide prompt treatment of acute airflow obstruction and its accompanying symptoms** such as cough, chest tightness, shortness of breath, and wheezing. These medications include short-acting inhaled beta₂-agonists and oral steroids. Anticholinergics are included in special circumstances.

Inhaled Steroids: The Most Effective Long-Term-Control Medication for Asthma

The daily use of inhaled steroids results in the following:^{5,6,10-16}

- Asthma symptoms will diminish. Improvement will continue gradually (see study 1).
- Occurrence of severe exacerbations is greatly reduced.
- Use of quick-relief medication decreases (see study 2).
- Lung function improves significantly, as measured by peak flow, FEV₁, and airway hyperresponsiveness.

Problems due to asthma may return if patients stop taking inhaled steroids.

Frequency of dosing

Once-daily dosing with inhaled steroids for patients with mild asthma and twice-a-day dosing for many other patients, even with high doses of some preparations, have been effective.⁷⁻⁹

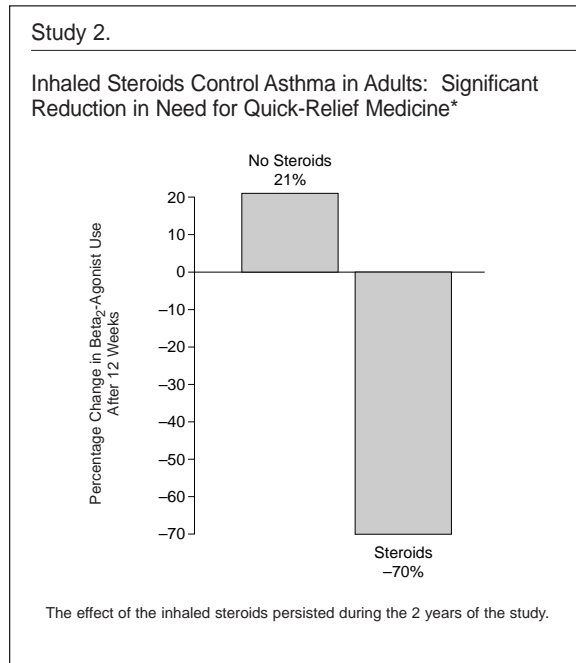
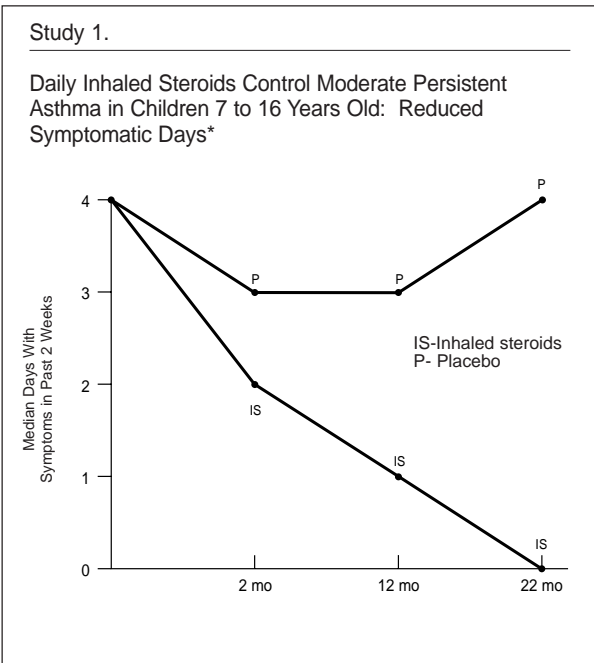

*Other endpoints—FEV₁, peak flow, airway hyperresponsiveness, and symptoms—significantly improved relative to the placebo group over 22 months of the children’s study (N=116)⁵ and over 2 years in the adult study (N=103).⁶

Stepwise Approach to Managing Asthma in Adults and in Children Over 5 Years of Age

All patients need to have a short-acting inhaled beta₂-agonist to take as needed for symptoms. Patients with mild, moderate, or severe persistent asthma require daily long-term-control medication to control their asthma.

See figure 4 for the recommended pharmacologic therapy at each level of asthma severity and pages 36-38 for dosage information. Also, see the glossary for the brand names of the medications mentioned in this guide.

Gaining Control of Asthma

The physician's judgment of an individual patient's needs and circumstances will determine at what step to initiate therapy. There are two appropriate approaches to gaining control of asthma:

- Start treatment at the step appropriate to the severity of the patient's asthma at the time of evaluation. If control is not achieved, gradually step up therapy until control is achieved and maintained.

OR

- At the onset, give therapy at a higher level to achieve rapid control and then step down to the minimum therapy needed to maintain control. A higher level of therapy can be accomplished by either adding a course of oral steroids to inhaled steroids, cromolyn, or nedocromil or using a higher dose of inhaled steroids.
- In the opinion of the Expert Panel, the **preferred approach is to start with more intensive therapy** in order to more rapidly suppress airway inflammation and thus gain prompt control.

If control is not achieved with initial therapy (e.g., within 1 month), the step selected, the therapy in the step, and possibly the diagnosis should be reevaluated.

Maintaining Control

Increases or decreases in medications may be needed as asthma severity and control vary over time. The Expert Panel's opinion is that **followup visits every 1 to 6 months are essential for monitoring asthma**. In addition, patients should be instructed to monitor their symptoms (and peak flow if used) and adjust therapy as described in the action plan (see Patient Handouts).

STEP DOWN THERAPY

Gradually reduce or "step down" long-term-control medications after several weeks or months of controlling persistent asthma (i.e., the goals of asthma therapy are achieved). In general, the last medication added to the medical regimen should be the first medication reduced.

Inhaled steroids may be reduced about 25 percent every 2 to 3 months until the lowest dose required to maintain control is reached. For patients with persistent asthma, anti-inflammatory medications should be continued.

For patients who are taking oral steroids daily on a long-term basis, referral for consultation or care by an asthma specialist is recommended. Patients should be closely monitored for adverse side effects. **Continuous attempts should be made to reduce daily use of oral steroids when asthma is controlled:**

- Maintain patients on the lowest possible dose of oral steroids (single dose daily or on alternate days).
- Use high doses of inhaled steroids to eliminate or reduce the need for oral steroids.

Figure 3.

Classification of Asthma Severity: Clinical Features Before Treatment

	Days With Symptoms	Nights With Symptoms	PEF or FEV ₁ *	PEF Variability
Step 4 Severe Persistent	Continual	Frequent	≤ 60%	>30%
Step 3 Moderate Persistent	Daily	≥5/month	>60%- <80%	>30%
Step 2 Mild Persistent	3-6/week	3-4/month	≥80%	20-30%
Step 1 Mild Intermittent	≤2/week	≤2/month	≥80%	<20%

* Percent predicted values for forced expiratory volume in 1 second (FEV₁) and percent of personal best for peak expiratory flow (PEF) (relevant for children 6 years old or older who can use these devices).

NOTES:

- Patients should be assigned to the most severe step in which *any* feature occurs. Clinical features for individual patients may overlap across steps.
- An individual’s classification may change over time.
- Patients at any level of severity of chronic asthma can have mild, moderate, or severe exacerbations of asthma. Some patients with intermittent asthma experience severe and life-threatening exacerbations separated by long periods of normal lung function and no symptoms.
- Patients with two or more asthma exacerbations per week (i.e., progressively worsening symptoms that may last hours or days) tend to have moderate-to-severe persistent asthma.

STEP UP THERAPY

The presence of one or more indicators of poor asthma control (see figure 6) may suggest a need to increase or “step up” therapy. Before increasing therapy, alternative reasons for poorly controlled asthma should be considered (see figure 7). Referral to a specialist for comanagement or consultation may be appropriate.

The addition of a 3- to 10-day course of oral steroids may be needed to reestablish control during a period of gradual deterioration or a moderate-to-severe exacerbation (see Managing Asthma Exacerbations, page 26). If symptoms do not recur after the course of steroids (and peak flow remains normal), the patient should continue in the same step. However, if the steroid course controls symptoms for less than 1 to 2 weeks, or if courses of steroids are repeated frequently, the patient should move to the next higher step in therapy.

Special Considerations for Infants, Children, and Adolescents

Infants and Preschool Children

Treatment of acute or chronic wheezing or cough should follow the stepwise approach presented in figure 5. In general, physicians should do the following when infants and young children consistently require treatment for symptoms more than two times per week:

- Prescribe daily inhaled anti-inflammatory medication (inhaled steroids, cromolyn, or nedocromil) as long-term-control asthma therapy. A trial of cromolyn or nedocromil is often given to patients with mild persistent asthma.
- Monitor the response to therapy carefully (e.g., frequency of symptoms over 2 to 4 weeks).
- If benefits are sustained for at least 3 months, a step down in therapy should be attempted.

Figure 4.

Stepwise Approach for Managing Asthma in Adults and Children Over 5 Years Old: Treatment

Long-Term Control	
Preferred treatments are in bold print.	
Step 4 Severe Persistent	Daily medications: <ul style="list-style-type: none"> ■ Anti-inflammatory: inhaled steroid (high dose)* AND ■ Long-acting bronchodilator: either long-acting inhaled beta₂-agonist (adult: 2 puffs q 12 hours; child: 1-2 puffs q 12 hours), sustained-release theophylline, or long-acting beta₂-agonist tablets AND ■ Steroid tablets or syrup long term; make repeated attempts to reduce systemic steroid and maintain control with high-dose inhaled steroid.
Step 3 Moderate Persistent	Daily medication: <ul style="list-style-type: none"> ■ Either <ul style="list-style-type: none"> —Anti-inflammatory: inhaled steroid (medium dose)* OR —Inhaled steroid (low-to-medium dose)* and add a long-acting bronchodilator, especially for nighttime symptoms: either long-acting inhaled beta₂-agonist (adult: 2 puffs q 12 hours; child: 1-2 puffs q 12 hours), sustained-release theophylline, or long-acting beta₂-agonist tablets. ■ If needed <ul style="list-style-type: none"> —Anti-inflammatory: inhaled steroids (medium-to-high dose)* AND <ul style="list-style-type: none"> —Long-acting bronchodilator, especially for nighttime symptoms; either long-acting inhaled beta₂-agonist, sustained-release theophylline, or long-acting beta₂-agonist tablets.
Step 2 Mild Persistent	Daily medication: <ul style="list-style-type: none"> ■ Anti-inflammatory: either inhaled steroid (low dose)* or cromolyn (adult: 2-4 puffs tid-qid; child: 1-2 puffs tid-qid) or nedocromil (adult: 2-4 puffs bid-qid; child: 1-2 puffs bid-qid) (children usually begin with a trial of cromolyn or nedocromil). ■ Sustained-release theophylline to serum concentration of 5-15 mcg/mL is an alternative, but not preferred, therapy. Zafirlukast or zileuton may also be considered for those ≥12 years old, although their position in therapy is not fully established.
Step 1 Mild Intermittent	<ul style="list-style-type: none"> ■ No daily medication needed.
Quick-Relief	
All Patients	Short-acting bronchodilator: inhaled beta₂-agonist (2-4 puffs) as needed for symptoms. Intensity of treatment will depend on severity of exacerbation.

*See Estimated Comparative Daily Dosages for Inhaled Steroids on page 38.

NOTES:

- *The stepwise approach presents general guidelines to assist clinical decisionmaking. Asthma is highly variable; clinicians should tailor medication plans to the needs of individual patients.*
- **Gain control** as quickly as possible. Either start with aggressive therapy (e.g., add a course of oral steroids or a higher dose of inhaled steroids to the therapy that corresponds to the patient's initial step of severity); or start at the step that corresponds to the patient's initial severity and step up treatment, if necessary.
- **Step down:** Review treatment every 1 to 6 months. Gradually decrease treatment to the least medication necessary to maintain control.
- **Step up:** If control is not maintained, consider step up. Inadequate control is indicated by increased use of short-acting beta₂-agonists and in: step 1 when patient uses a short-acting beta₂-agonist more than two times a week; steps 2 and 3 when patient uses short-acting beta₂-agonist on a daily basis or more than three to four times in 1 day. But before stepping up: Review patient inhaler technique, compliance, and environmental control (avoidance of allergens or other precipitant factors).
- A course of oral steroids may be needed at any time and at any step.
- Patients with exercise-induced bronchospasm should take two to four puffs of an inhaled beta₂-agonist 5 to 60 minutes before exercise.
- Referral to an asthma specialist for consultation or comanagement is *recommended* if there is difficulty maintaining control or if the patient requires step 4 care. Referral may be *considered* for step 3 care.
- For a list of brand names, see glossary.

Figure 5.

Stepwise Approach for Managing Infants and Young Children (5 Years of Age and Younger) With Acute or Chronic Asthma Symptoms

Long-Term Control	
Step 4 Severe Persistent	<ul style="list-style-type: none"> ■ Daily anti-inflammatory medication <ul style="list-style-type: none"> — High-dose inhaled steroid* with spacer and face mask — If needed, add oral steroids (2 mg/kg/day); reduce to lowest daily or alternate-day dose that stabilizes symptoms
Step 3 Moderate Persistent	<ul style="list-style-type: none"> ■ Daily anti-inflammatory medication. Either: <ul style="list-style-type: none"> — Medium-dose inhaled steroid* with spacer and face mask Once control is established, consider: <ul style="list-style-type: none"> — Lower medium-dose inhaled steroid* with spacer and face mask and nedocromil (1-2 puffs bid-qid) OR <ul style="list-style-type: none"> — Lower medium-dose inhaled steroid* with spacer and face mask and theophylline (10 mg/kg/day up to 16 mg/kg/day for children ≥ 1 year of age, to a serum concentration of 5-15 mcg/mL)**
Step 2 Mild Persistent	<ul style="list-style-type: none"> ■ Daily anti-inflammatory medication. <ul style="list-style-type: none"> — Infants and young children usually begin with a trial of cromolyn (nebulizer is preferred—1 ampule tid-qid; or MDI—1-2 puffs tid-qid) or nedocromil (MDI only—1-2 puffs bid-qid) OR <ul style="list-style-type: none"> — Low-dose inhaled steroid* with spacer and face mask
Step 1 Mild Intermittent	<ul style="list-style-type: none"> ■ No daily medication needed.
Quick-Relief	
All Patients	Bronchodilator as needed for symptoms: Short-acting inhaled beta ₂ -agonist by nebulizer (0.05 mg/kg in 2-3 cc of saline) or inhaler with face mask and spacer (2-4 puffs; for exacerbations, repeat q 20 minutes for up to 1 hour) or oral beta ₂ -agonist.
	<p>With viral respiratory infection, use short-acting inhaled beta₂-agonist q 4 to 6 hours up to 24 hours (longer with physician consult) but, in general, if repeated more than once every 6 weeks, consider moving to next step up. Consider oral steroids if the exacerbation is moderate to severe or at the onset of the infection if the patient has a history of severe exacerbations.</p>

* See Estimated Comparative Dosages for Inhaled Steroids on page 38.

** For children <1 year of age: usual max mg/kg/day = 0.2 (age in weeks) + 5.

NOTES:

- *The stepwise approach presents general guidelines to assist clinical decisionmaking. Asthma is highly variable; clinicians should tailor medication plans to the needs of individual patients.*
- **Gain control** as quickly as possible. Either start with aggressive therapy (e.g., add a course of oral steroids or a higher dose of inhaled steroids to the therapy that corresponds to the patient's initial step of severity); or start at the step that corresponds to the patient's initial severity and step up treatment, if necessary.
- **Step down.** Review treatment every 1 to 6 months. If control is sustained for at least 3 months, a gradual stepwise reduction in treatment may be possible.
- **Step up.** If control is not achieved, consider step up. Inadequate control is indicated by increased use of short-acting beta₂-agonists and in: step 1 when patient uses a short-acting beta₂-agonist more than two times a week; steps 2 and 3 when patient uses short-acting beta₂-agonist on a daily basis OR more than three to four times a day. But before stepping up: review patient inhaler technique, compliance, and environmental control (avoidance of allergens or other precipitant factors).
- A course of oral steroids (prednisolone) may be needed at any time and step.
- Referral to an asthma specialist for consultation or comanagement is *recommended* for patients requiring step 3 or 4 care. Referral may be *considered* for step 2 care.
- For a list of brand names, see glossary.

- If clear benefit is not observed, treatment should be stopped. Alternative therapies or diagnoses should be considered.
- Consider oral steroids if an exacerbation caused by a viral respiratory infection is moderate to severe. If the patient has a history of severe exacerbations, consider steroids at the onset of the viral infection.

Medication delivery devices should be selected according to the child's ability to use them. Be aware that the dose received can vary considerably among delivery devices:

- **Children aged 2 or less**—nebulizer therapy is preferred for administering cromolyn or high doses of short-acting inhaled beta₂-agonists. A metered-dose inhaler (MDI) with a spacer/holding chamber that has a face mask may be used to take inhaled steroids.

- **Children 3 to 5 years of age**—MDI plus spacer/holding chamber may be used by many children of this age. If the desired therapeutic effects are not achieved, a nebulizer or an MDI plus spacer/holding chamber with a face mask may be required.

Spacers/holding chambers are devices that hold the aerosol medication so the patient can inhale it easily. This reduces the problem of coordinating the actuation of the MDI with the inhalation. Spacers/holding chambers come in many different shapes. These devices are not simply tubes that put space between the patient's mouth and the MDI. Examples of spacers/holding chambers are illustrated in the box on page 14.

Parents or caregivers need to be instructed in the proper use of appropriately sized face masks, spacers with face masks, and holding chamber devices. Acceptable use of the delivery device should be demonstrated in the office before the patient leaves. The ability of children to use the devices may vary widely.

Figure 6.

Indicators of Poor Asthma Control—Consider Increasing Long-Term Medications*

- **Awakened at night with symptoms**
- **An urgent care visit**
- **Patient has increased need for short-acting inhaled beta₂-agonists** (excludes use for upper respiratory viral infections and exercise-induced bronchospasm) OR
 - At step 1: Used short-acting inhaled beta₂-agonists more than two times in a week
 - At steps 2-3: Used short-acting inhaled beta₂-agonists more than three to four times a day OR used this medication on a daily basis for a week or less
 - Patient used more than one canister of short-acting inhaled beta₂-agonist in one month

* This may mean a temporary increase in anti-inflammatory medication to regain control or a "step up" in long-term therapy. This will depend on the frequency of the above events, reasons for poor control (see figure 7), and the clinician's judgment.

Figure 7.

Assess Reasons for Poor Asthma Control Before Increasing Medications—ICE

- **Inhaler technique** Check patient's technique.
- **Compliance** Ask when and how much medication the patient is taking.
- **Environment** Ask patient if something in his or her environment has changed.

Also consider:

- **Alternative diagnosis** Assess patient for presence of concomitant upper respiratory disease or alternative diagnosis.

School-Age Children and Adolescents

The pharmacologic management of school-age children and adolescents follows the same basic principles as those for adults, but with special consideration of growth, school, and social development.

- **Cromolyn or nedocromil is often tried first in children with mild or moderate persistent asthma.** This is because these medications are often effective anti-inflammatory therapies and have no known long-term systemic effects.
- **For children with severe persistent asthma, and for many with moderate persistent asthma, inhaled steroids are necessary for long-term-control therapy.** Cromolyn and nedocromil do not provide adequate control for these patients. See stepwise approach to pharmacotherapy (figure 4 on page 11) for treatment recommendations.

Examples of Spacer/Holding Chamber Devices

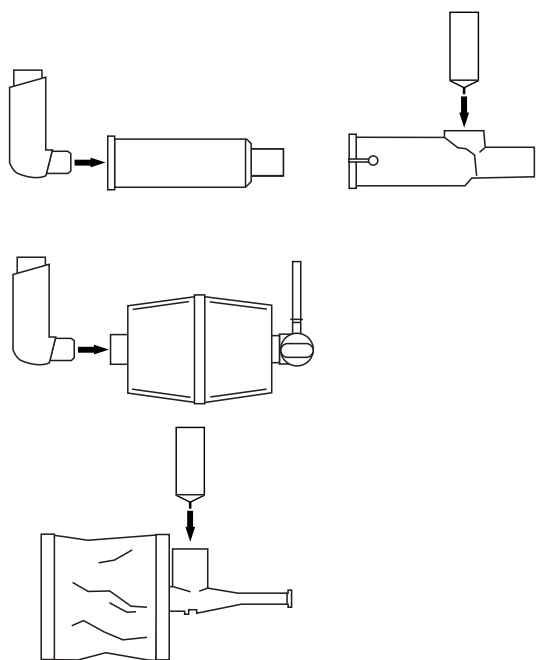

INHALED STEROIDS AND GROWTH

The potential but small risk of adverse effects on linear growth from the use of inhaled steroids is well balanced by their efficacy. Poor asthma control itself can result in retarded linear growth. Most studies do not demonstrate a negative effect on growth with dosages of 400 to 800 mcg a day of beclomethasone,²¹⁻²³ although a few short-term studies have.^{24,25} Adverse effects on linear growth appear to be dose dependent. High doses of inhaled steroids have greater potential for growth suppression, but less potential than the alternative of oral steroids. Some caution (e.g., monitoring growth, stepping down therapy when possible) is suggested while this issue is studied further.

ACTION PLAN FOR SCHOOLS

The clinician should prepare a written action plan for the student's school that explains when medications may be needed to treat episodes and to prevent exercise-induced bronchospasm. Recommendations to limit exposures to offending allergens or irritants and a written request for the child to carry quick-relief medications at school could be helpful. When possible, schedule daily medications so they do not need to be taken at school. (See patient handout, "School Self-Management Plan")

Managing Asthma in Older Adults

- Make adjustments or avoid asthma medications that can aggravate other conditions:
 - **Inhaled steroids.** Give supplements of calcium (1,000 to 1,500 mg per day), vitamin D (400 units a day), and, where appropriate, estrogen replacement therapy, especially for women using high doses of inhaled steroids.
 - **Oral steroids** may provoke confusion, agitation, and changes in glucose metabolism.
 - **Theophylline and epinephrine** may exacerbate underlying heart conditions. Also, the risk of theophylline overdose may be higher because of reduced theophylline clearance in older patients.

- Inform patients about potential adverse effects on their asthma from medications used for other conditions, for example:
 - **Aspirin and other oral nonsteroidal anti-inflammatory medications** (arthritis, pain relief)
 - **Nonselective beta-blockers** (high blood pressure)
 - **Beta-blockers in some eye drops** (glaucoma)
- Chronic bronchitis and emphysema may coexist with asthma. A 2- to 3-week trial with oral steroids can help determine the presence of reversibility of airway obstruction and indicate the extent of potential benefit from asthma therapy.

Managing Special Situations

Managing Exercise-Induced Bronchospasm

Exercise-induced bronchospasm generally begins during exercise and reaches its peak 5 to 10 minutes after stopping. The symptoms often spontaneously resolve in another 20 to 30 minutes.

A diagnosis of exercise-induced bronchospasm is suggested by a history of cough, shortness of breath, chest pain or tightness, wheezing, or endurance problems during and after vigorous activity. The diagnosis can be confirmed by an objective measure of the problem (i.e., a 15 percent decrease in peak flow or FEV₁ between measurements taken before and after vigorous activity at 5-minute intervals for 20 to 30 minutes.)

For the vast majority of patients, exercise-induced bronchospasm should not limit either participation or success in vigorous activities. The following are the **recommended control measures**:

- **Two to four puffs of short-acting beta₂-agonist 5 to 60 minutes before exercise**, preferably as close to the start of exercise as possible. The effects of this pretreatment should last approximately 2 to 3

hours. A long-acting inhaled beta₂-agonist taken at least 30 minutes before exercise will last 10 to 12 hours.²⁶ Cromolyn or nedocromil can also be used before exercise with a duration of effect of 1 to 2 hours.²⁷⁻²⁹

- **A 6- to 10-minute warmup period before exercise** may benefit patients who can tolerate continuous exercise with minimal symptoms. The warmup may preclude a need for repeated medications.
- **Increase in long-term-control medications, if appropriate.** If symptoms occur with usual activities or exercise, a step up in long-term-control therapy may be warranted. Long-term control of asthma with anti-inflammatory medication (i.e., inhaled steroid, cromolyn, or nedocromil) can reduce the frequency and severity of exercise-induced bronchospasm.³⁰

Teachers and coaches need to be notified that a child has exercise-induced bronchospasm. They should be told that the child is able to participate in activities but may need inhaled medication before activity. Athletes should disclose the medications they use and adhere to standards set by the U.S. Olympic Committee.³¹

A complete, easy-to-use list of prohibited and approved medications can be obtained from the U.S. Olympic Committee's Drug Control Hotline (1-800-233-0393).

Managing Seasonal Asthma Symptoms

- **During the allergy season:** Use the stepwise approach to the long-term management of asthma to control symptoms.
- **Before the season:** If symptoms during a season are predictable, start daily anti-inflammatory therapy (inhaled steroids, cromolyn, or nedocromil) just before the anticipated onset of symptoms and continue this throughout the season.

Managing Asthma in Patients Undergoing Surgery

- Evaluate the patient's asthma over the past 6 months.
- Improve lung function to predicted values before surgery, possibly with a short course of oral steroids.
- Give patients who have received oral steroids for longer than 2 weeks during the past 6 months 100 mg of hydrocortisone every 8 hours intravenously during the surgical period. Reduce the dose rapidly within 24 hours following surgery.

Managing Asthma in Pregnant Women

Management of asthma in pregnant women is essential and is achieved with basically the same treatment as for nonpregnant women. Poorly controlled asthma during pregnancy can result in reduced oxygen supply to the fetus, increased perinatal mortality, increased prematurity, and low birth weight.³² There is little to suggest an increased risk to the fetus for most drugs used to treat asthma.

Drugs or drug classes with potential risk to the fetus include brompheniramine, epinephrine, and alpha-adrenergic compounds (other than pseudoephedrine),³³⁻³⁵ decongestants (other than pseudoephedrine), antibiotics (tetracycline, sulfonamides, and ciprofloxacin), live virus vaccines, immunotherapy (initiation or increase in doses), and iodides.

Assessment and monitoring
Pharmacologic therapy
▶ Control of factors contributing to asthma severity
▶ Patient education for a partnership

3 Control of Factors Contributing to Asthma Severity

Avoiding or controlling factors that contribute to asthma severity will reduce symptoms and the need for medications. (See figure 8).

Patient Assessment and Education

Have each patient complete the “Patient Self-Assessment Form for Environmental and Other Factors That Can Make Asthma Worse” to assess exposures and identify factors that may contribute to asthma severity.

Educate patients in how to reduce their exposures to these factors (see patient handout, “How To Control Things That Make Your Asthma Worse,” and box on page 19). Confirm suspected occupational exposures by having the patient record over 2 to 3 weeks symptoms, exposures, bronchodilator use, and peak flow at and away from work.

Inhaled Allergens and Persistent Asthma

To reduce the effects of specific allergens on a patient with persistent asthma (see figure 9):

- **Identify the specific allergens to which patient is exposed** (use “Patient Self- Assessment Form for Environmental and Other Factors That Can Make Asthma Worse”).
- **Determine and confirm sensitivity to the allergens** (skin or in vitro tests, medical history).
- **Obtain agreement with the patient to initiate one or two simple control measures** (see patient handout, “How To Control Things That Make Your Asthma Worse,” and box on page 19).

Figure 8.

Allergen Control Significantly Improves Even Mild Asthma: An Illustrative Study With House-Dust Mites

Many studies support the effectiveness of allergen control in improving asthma and reducing the need for medication.^{36,39} The controlled study of 20 children with mild asthma and house-dust mite allergy illustrates the effect control measures can have.³⁹

- Major components of treatment used in the study:
 - Encased pillows, mattresses, and box springs in allergen-impermeable covers.
 - Washed blankets and mattress pads every 2 weeks in hot water.
 - Removed toys, upholstered furniture, and carpets from bedroom.
- After 1 month, the treatment group had:
 - Symptom days and days needing medicine significantly reduced to a minimal number
 - Airway hyperresponsiveness reduced significantly relative to the control group.

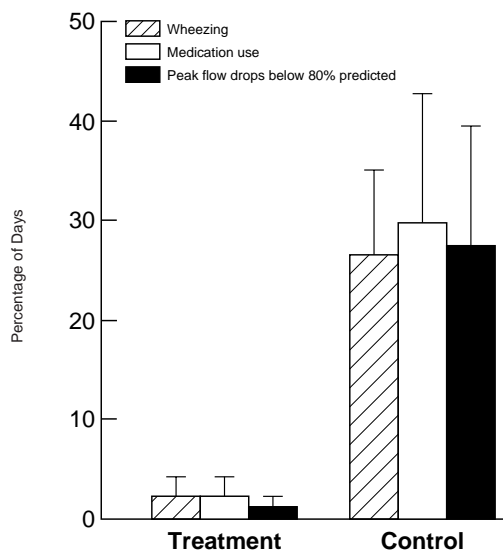

Percentage of days (± standard error) in which wheezing was noticed, medication was used, or peak flow dropped below 80% predicted.³⁹ Reproduced with permission.

Figure 9.

Determining the Need for Allergen Control in Patients With Persistent Asthma

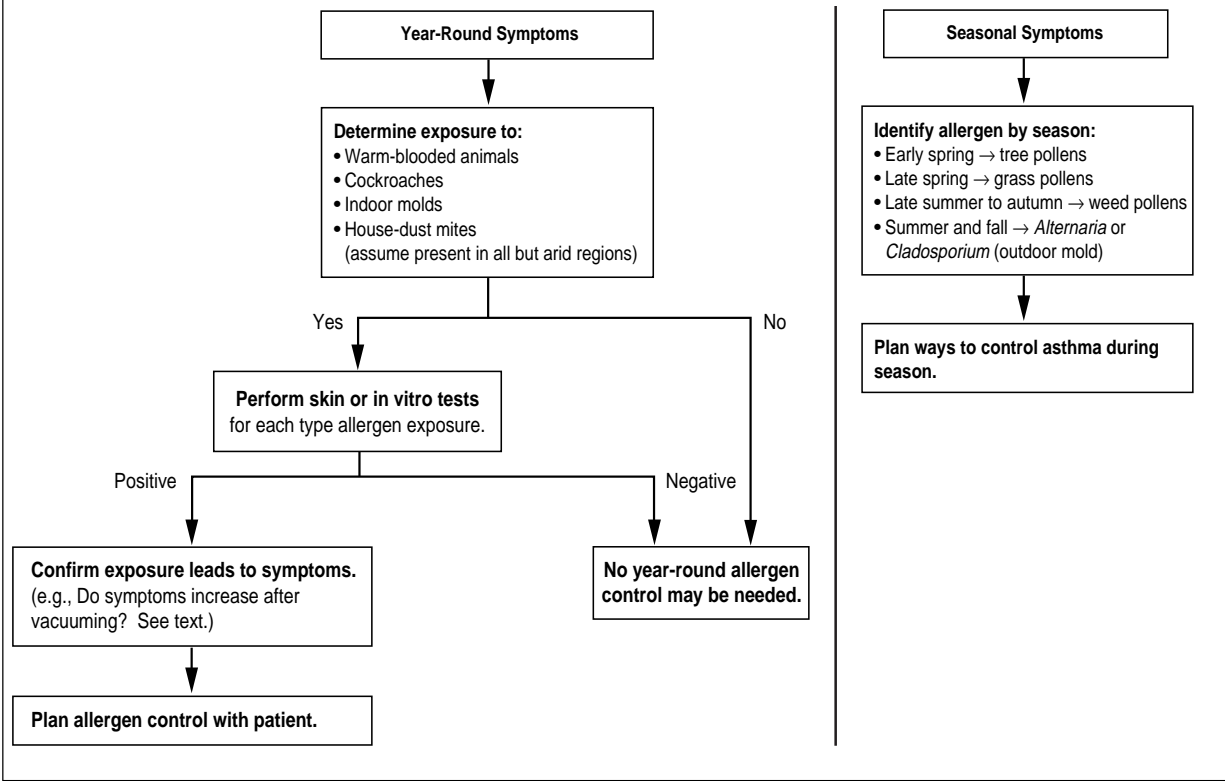

■ **Follow up with patient, adding control measures after first ones are implemented.**

Let the patient know that the benefits of many control measures will take some time to be felt. For dust-mite control it can take less than a month, whereas the benefits from removing an animal from the home may take 6 months or longer to become apparent. This is how long it may take before all the dander is out of the environment.

Allergy Testing

Skin or in vitro (e.g., RAST) tests are alternative methods to assess the sensitivity to the year-round allergens to which patients with persistent asthma are exposed (i.e., animal, house-dust mite, cockroach, or indoor mold allergens). Allergy testing is the only reliable way to determine sensitivity to year-round

indoor allergens^{40,41} and is important for justifying the expense and effort involved in implementing environmental controls. Allergy tests also reinforce for the patients the need to take environmental control measures. Whether skin or in vitro tests are used will probably depend on whether the physician is knowledgeable about skin testing technique.

Order tests only for those substances to which you have determined the patient is exposed (i.e., do not order a panel of tests). **When allergy tests are positive, ask patients about the onset of symptoms when they are in contact with the allergen.** Positive answers to these questions confirm the likelihood that the allergy is contributing to asthma symptoms. However, lack of a positive response to these questions does not exclude the possibility that the allergen may be contributing to the patient’s symptoms.

Control Measures for Factors Contributing to Asthma Severity

Factors Contributing to Asthma Severity	Control Measures: Instructions to Patients
Allergens	See patient handout, "How To Control Things That Make Your Asthma Worse."
Tobacco smoke	Strongly advise patient and others living in the home to <i>stop smoking</i> . Discuss ways to reduce exposure to other sources of tobacco smoke, such as from day care providers and the workplace.
Rhinitis	Intranasal steroids. Antihistamine/decongestant combinations may also be used.
Sinusitis	Medical measures to promote drainage. Antibiotic therapy is appropriate when complicating acute bacterial infection is present.
Gastroesophageal reflux	No eating within 3 hours of bedtime, head of bed elevated 6 to 8 inches, and appropriate medications (e.g., H ₂ -antagonist).
Sulfite sensitivity	No eating of shrimp, dried fruit, processed potatoes. No drinking of beer or wine.
Medication interactions	No beta-blockers (including ophthalmological preparations). Aspirin and other nonsteroidal anti-inflammatory medications. Inform adult patients with severe persistent asthma, nasal polyps, or a history of aspirin sensitivity about the risk of severe and even fatal episodes from using these drugs. Usually safe alternatives are acetaminophen or salsalate.
Occupational exposures	Discuss with asthma patients the importance of avoidance, ventilation, respiratory protection, and a tobacco smoke-free environment. If occupationally induced asthma, recommend complete cessation of exposure to initiating agent. Obtain permission from patient before contacting management or onsite health professionals about workplace exposure.
Viral respiratory infections	Annual influenza vaccinations should be given to patients with persistent asthma.

- **For animals and dust mites:** "Do nasal, eye, or chest symptoms occur in a room where carpets are being or have just been vacuumed?"
- **For indoor mold:** "Do nasal, eye, or chest symptoms appear when in damp or moldy rooms, such as basements?"

Immunotherapy

In the opinion of the Expert Panel and based on the evidence,⁴²⁻⁴⁶ allergen immunotherapy may be considered for asthma patients when (1) there is clear evidence of a relationship between symptoms and exposure to an

unavoidable allergen to which the patient is sensitive, (2) symptoms occur all year or during a major portion of the year, and (3) there is difficulty controlling symptoms with pharmacologic management because multiple medications are required or medications are ineffective or not accepted by the patient. The course of allergen immunotherapy is typically of 3 to 5 years' duration. If use of allergen immunotherapy is elected, it should be administered only in a medical office where facilities and trained personnel are available to treat any life-threatening reaction that can, but rarely does, occur.^{47,48} In the Expert Panel's opinion, referral to an allergist should be made when patients are being considered for immunotherapy.

Assessment and monitoring
Pharmacologic therapy
Control of factors contributing to asthma severity
Patient education for a partnership

4 ■ Periodic Assessment and Monitoring

Periodic clinical assessments every 1 to 6 months and patient self-monitoring are essential for asthma care because:

- Asthma symptoms and severity change, requiring changes in therapy.
- Patients' exposure to precipitants of asthma will change.
- Patients' memories and self-management practices fade with time. Reinforcement, review, and reminders are needed.

The frequency of patient visits depends on the severity of the asthma and the patient's ability to control and monitor symptoms. The first followup visit usually needs to be sooner than 1 month.

Working Within the Time Constraints of the Typical Office Visit

Each physician develops his or her own way of accomplishing the periodic assessment and patient education (see box on page 21 for an example). Here are ways some primary care physicians have been able to perform the recommended periodic assessment and patient education within the time constraints of routine office visits:

- **Give patients an assessment questionnaire to complete in the waiting room.** The answers to these questions determine the issues to be addressed during that visit. See "Patient Self-Assessment Form for Followup Visits" on page 50 for such an assessment questionnaire. This helps set priorities to be addressed.
- **Have patients come back to the office more often, especially at the beginning.** Break the assessment and education the patient needs into segments and perform these over a number of visits. For example, after the diagnosis of asthma, a patient could be given the "Patient Self-Assessment Form for Environmental and Other Factors That Can Make Asthma Worse" to be completed at home. A visit in a week or so could be set to review the form and your recommendations to the patient. Similarly, initial education on the use of a peak flow meter and action plan might be scheduled for a separate visit. An example of how the necessary patient education can be divided and conducted across visits is outlined in figure 10 on page 24. Review this and make adjustments, as needed, for your own practice.
- **Use nurses or office staff to do some of the tasks,** like checking MDI technique.
- Some managed care organizations have a home case manager to do followup assessments and education.

Patient Self-Monitoring

All patients should be taught to recognize symptoms and what to do when symptoms occur (see patient handout, “Asthma Action Plan”). Review the information in the Asthma Action Plan often, optimally at each office visit.

Long-term daily peak flow monitoring is recommended for those with moderate or severe persistent asthma or patients with a history of severe exacerbations. If long-term daily peak flow monitoring is not used by these patients, short-term monitoring (2 to 3 weeks) can be used to evaluate the severity of exacerbations to guide treatment decisions, evaluate response to changes in long-term treatment, and identify environmental or occupational exposures.

Educate patients on how to use the peak flow meter to help monitor and manage their asthma (see patient handout, “How To Use Your Peak Flow Meter,” for details). Ask patients to demonstrate the use of their peak flow

meter at every visit and use the reading as part of the clinical assessment. This will take less than a minute and should become a routine component of the clinic visit.

Specific recommendations regarding peak flow monitoring include:

- Use the patient’s own personal best peak flow (see patient handout, “How To Use Your Peak Flow Meter”) as the standard against which peak flow measurements should be compared.
- Use the same peak flow meter and, when needed, replace with same brand.
- Measure peak flow first thing in the morning before medications.
- A drop in peak flow below 80 percent of personal best indicates a need for added medications.
- A drop in peak flow below 50 percent of personal best indicates a severe exacerbation.

Spirometry and Peak Flow Measurement at Office Visits

The Expert Panel recommends that spirometry tests be done (1) at the initial assessment, (2) after treatment has stabilized symptoms and peak flow (to document a baseline of “normal” airway function), and (3) at least every 1 to 2 years when asthma is stable, more often when asthma is unstable, or at other times the clinician believes it is needed.

How I Organized My Visits To Accomplish the Periodic Assessment and Patient Education

- My staff gives asthma patients a self-assessment form to complete in the waiting room.
- My nurse evaluates the patients’ inhaler technique and checks their peak flow before they see me.
- I am then able to direct my care to the patients’ and families’ concerns, problems in achieving the goals of therapy, medication issues, and other concerns I may identify with open-ended questions.



I feel my office has been very successful with this organized approach to the asthma office visit. It obviously required energy to organize the system and practice on the part of myself and my staff to make it work. But the routine periodic assessment and patient education needed for good asthma care are doable in the typical office visit.

Stuart Stoloff, MD
Private Family Practice
Carson City, Nevada

Clinician Assessment

At each visit, (1) identify patient's concerns about asthma and expectations for the visit, (2) assess achievement of the patient's goals and the general goals of asthma therapy, (3) review medications usage, and (4) teach and reinforce patient's self-management activities (the latter is addressed in the next chapter on "Education for a Partnership in Asthma Care"). These four activities can be achieved within the time constraints of routine medical visits, particularly when the patient completes the "Patient Self-Assessment Form for Followup Visits" in the waiting room.

Identify Patient Concerns and Expectations of the Visit

Review the self-assessment questionnaire and address the patient's concerns during the visit.

Assess Achievement of the Goals of Asthma Therapy

If the patient is not meeting the following goals of asthma therapy, assess the reasons (see figure 7 on page 13) and consider increasing the patient's medications.

Prevent chronic asthma symptoms and asthma exacerbations during the day and night.

- Perform physical examination (respiratory tract).
- Review patient's symptom history at each visit:
 - Daytime symptoms in the past 2 weeks
 - Nighttime symptoms in the past 2 weeks
 - Symptoms while exercising
 - Cause(s) of the symptoms
 - What the patient did to control the symptoms
- Use of quick-relief medications:
 - Number of times short-acting inhaled beta₂-agonists are used per week
 - Number of short-acting inhaled beta₂-agonist inhalers used in past month

- Emergency or hospital care.
- Missed any work or school due to asthma.

Maintain normal activity levels—including exercise and other physical activities.

- Reduction in usual activities or exercise.
- Disruption of caregivers' or parents' routine by their child's asthma.

Have normal or near-normal lung function.

- Objective measure of lung function—either spirometry or peak flow at each visit (see box on page 21).
- Number of times peak flow went below 80 percent personal best in past 2 weeks, if peak flow monitoring is performed.

Be satisfied with the asthma care received and the level of control—ask patient about this.

Have no or minimal side effects—shakiness, nervousness, bad taste, sore throat, cough, upset stomach—while receiving optimal medications.

Review Medications Usage and Skills

- Ask patients to review for you what medications they are taking, when they take them, and how often.
- Identify any problems patients have had taking medications as prescribed (e.g., missed doses). Note: Patients should bring all of their medications to each office visit.
- Ask patients to demonstrate their use of a placebo inhaler at each followup visit. Assess their performance using the checklist in the patient handout (see patient handout, "How To Use Your Metered-Dose Inhaler the Right Way"). Ask patients to demonstrate use of their peak flow meter, if used.

Assessment and monitoring
Pharmacologic therapy
Control of factors contributing to asthma severity
▶ Patient education for a partnership

5 Education for a Partnership in Asthma Care

The goal of all patient education is to help patients take the actions needed to control their asthma.

These actions are listed below and are described more fully in the patient handouts. See figure 10 on page 24 for an example of how to address these issues during routine office visits.

- Taking daily medications for long-term control as prescribed
- Using delivery devices effectively—metered-dose inhalers, spacers, nebulizers
- Identifying and controlling factors that make asthma worse
- Monitoring peak flow and/or symptoms
- Following the written action plan when symptoms or episodes occur

How To Increase the Likelihood of Compliance

Patients cannot be expected to perform a task they never agreed to do or one that is only mentioned once to them. Thus, two essential clinician activities for successful patient education are:

1. **Asking the patient for a verbal, sometimes written, agreement** to take specific action(s). You will need to explain the recommended action(s) and the benefits the patient can expect from doing them.
2. **Following up** and reinforcing the patient for the actions during subsequent visits or phone calls.

Other ways to increase compliance are:

- **Develop an Asthma Action Plan with the patient** (see patient handout). Involve adolescents and school-age children in developing their plan, as appropriate. Minimize the number of medications and daily doses to the fewest clinically possible. Give parents additional copies of the plan to give to day care providers and schools.
- **Fit the daily medication regimen into the patient’s and family’s routine.** Explain the difference between long-term-control and quick-relief medicines and how to use them. Ask patients (and parents) when would be the easiest times for them to take their daily medicines.
- **Identify and address obstacles and concerns. Ask patients about problems they think they might have doing the recommended action(s).** Ask questions that start with “what” or “how” to identify the obstacles (e.g., “What are things that might make it hard for you to take the action each day?”). Discuss ways to address the problems or provide alternative actions.
- **Ask for agreement/plans to act.** Ask patients to summarize what recommended action(s) they plan to take, especially at the end of each visit.
- **Encourage or enlist family involvement.**
- **Follow up. At each visit, review the performance of the agreed-upon actions.** Praise appropriate actions and discuss how to improve other actions. Share evidence of the patient’s improvement in lung function and symptoms. Remain encouraging when patients do not take the agreed-upon actions.

Figure 10.

Example of Delivery of Asthma Education by Clinicians During Patient Care Visits

Recommendations for Initial Visit		
Assessment Questions Focus on: ■ Concerns ■ Goals of Therapy ■ Quality of Life ■ Expectations	Teach information in simple language	Teach and demonstrate skills
<p>“What worries you most about your asthma?”</p> <p>“What do you want to accomplish at this visit?”</p> <p>“What do you want to be able to do that you can’t do now because of your asthma?”</p> <p>“What do you expect from treatment?”</p> <p>“What medicines have you tried?”</p> <p>“What other questions do you have for me today?”</p>	<p>What is asthma? A chronic lung disease. The airways are very sensitive. They become inflamed and narrow; breathing becomes difficult.</p> <p>Two types of medicines are needed:</p> <ul style="list-style-type: none"> ■ Long-term control: medications that prevent symptoms, often by reducing inflammation ■ Quick relief: short-acting bronchodilator relaxes muscles around airways <p>Bring all medications to every appointment.</p> <p>When to seek medical advice. Provide appropriate telephone number.</p>	<p>Inhaler (see patient handout) and spacer/holding chamber use. Check performance.</p> <p>Self-monitoring skills tied to action plan:</p> <ul style="list-style-type: none"> ■ Recognize intensity and frequency of asthma symptoms ■ Review the signs of deterioration and the need to reevaluate therapy: <ul style="list-style-type: none"> — Waking at night with asthma — Increased medication use — Decreased activity tolerance <p>Use of an action plan (see patient handout)</p>
Recommendations for First Followup Visit (2 to 4 weeks or sooner as needed)		
<p>Ask relevant questions from previous visit and also ask:</p> <p>“What medications are you taking?”</p> <p>“How and when are you taking them?”</p> <p>“What problems have you had using your medications?”</p> <p>“Please show me how you use your inhaled medications.”</p>	<p>Use of two types of medications. Remind patient to bring all medications and the peak flow meter to every appointment for review.</p> <p>Self-evaluation of progress in asthma control using symptoms and peak flow as a guide.</p>	<p>Use of an action plan. Review and adjust as needed.</p> <p>Peak flow monitoring (see patient handout) and daily diary recording.</p> <p>Correct inhaler and spacer/holding chamber technique.</p>
Recommendations for Second Followup Visit		
<p>Ask relevant questions from previous visits and also ask:</p> <p>“Have you noticed anything in your home, work, or school that makes your asthma worse?”</p> <p>“Describe for me how you know when to call your doctor or go to the hospital for asthma care.”</p> <p>“What questions do you have about the action plan?” “Can we make it easier?”</p> <p>“Are your medications causing you any problems?”</p>	<p>Relevant environmental control/avoidance strategies (see patient handout).</p> <ul style="list-style-type: none"> ■ How to identify and control home, work, or school exposures that can cause or worsen asthma ■ How to avoid cigarette smoke (active and passive) <p>Review all medications and review and interpret peak flow and symptom scores from daily diary</p>	<p>Inhaler/spacer/holding chamber technique.</p> <p>Peak flow monitoring technique.</p> <p>Review use of action plan. Confirm that patient knows what to do if asthma gets worse.</p>
Recommendations for All Subsequent Visits		
<p>Ask relevant questions from previous visits and also ask:</p> <p>“How have you tried to control things that make your asthma worse?”</p> <p>“Please show me how you use your inhaled medication.”</p>	<p>Review and reinforce all:</p> <ul style="list-style-type: none"> ■ Educational messages ■ Environmental control strategies at home, work, or school ■ Medications <p>Review and interpret peak flow and symptom scores from daily diary.</p>	<p>Inhaler/spacer/holding chamber technique.</p> <p>Peak flow monitoring technique.</p> <p>Review use of action plan. Confirm that patient knows what to do if asthma gets worse. Periodically review and adjust written action plan.</p>

- **Assess the influence of the patient’s cultural beliefs and practices that might affect asthma care.** Ask open-ended questions (e.g., “What will your friends and family think when you tell them you have asthma? What advice might they give to you?”) If harmless or potentially beneficial folk remedies are mentioned by the patients, consider incorporating them into the treatment plan.

Teach Use of Inhaler and Peak Flow Meter

Most patients use their inhalers incorrectly, and this skill deteriorates over time. Patients’ poor technique results in less medication getting to the airways. The initial inhaler training can be done in minutes with the simple skills-training method described below. Note that different inhalers may require different inhalation techniques. The necessary reviews at each visit are quick and easy and can be done by other staff members in the office.

Effective skills-training steps for teaching inhaler techniques are as follows:

1. **Tell** the patient the steps and give written instructions. (For written instructions, see patient handouts.)
2. **Demonstrate** how to use the inhaler following each of these steps.
3. Ask the patient to **demonstrate** how to use the inhaler. Let the patient refer to the handout on the first training. Subsequently, use the handout as a checklist to assess the patient’s technique.

4. **Tell** patients what they did right and what they need to improve. Have them demonstrate their technique again, if needed. Focus the patient on improving one or two key steps (e.g., timing of actuation and inhalation) if the patient made multiple errors.

At each subsequent visit, perform the last two steps: patient demonstration and telling what they did right and what they need to improve. Train patients to use their peak flow meter using the same four skills-training steps above and the patient handout, “How To Use Your Peak Flow Meter.”

Tips for Replacing Metered-Dose Inhalers

The only reliable way to determine whether a metered-dose inhaler is empty is to count the number of puffs used and subtract that number from the total number of sprays in the canister. Unfortunately, many patients believe they know when their inhalers are empty by floating the canister, spraying into the air, or tasting the medicine.

Clinicians and pharmacists can help patients determine the life of their long-term-control canisters by referring to the chart in figure 11 (“How Often To Change Long-Term-Control Canisters”) or by dividing the number of sprays per canister (written on the canister and listed in the dosage chart on page 36) by the number of puffs prescribed per day. Determine the corresponding calendar date. Make an appointment before that date or make refills available after that date.

Figure 11.

How Often To Change Long-Term-Control Canisters

# Sprays	2 Sprays/Day	4 Sprays/Day	6 Sprays/Day	8 Sprays/Day	9 Sprays/Day	12 Sprays/Day	16 Sprays/Day
60	30 days	15 days	n/a	n/a	n/a	n/a	n/a
100	n/a	25 days	16 days	12 days	n/a	n/a	n/a
104	n/a	26 days	17 days	13 days	n/a	n/a	n/a
112	n/a	28 days	18 days	14 days	n/a	n/a	n/a
120	60 days	30 days	20 days	15 days	n/a	n/a	n/a
200	n/a	50 days	33 days	25 days	22 days	16 days	12 days
240	n/a	60 days	40 days	30 days	26 days	20 days	15 days

* If the medication is taken as prescribed, the canister should be discarded as indicated above. Otherwise, the remaining puffs may not contain sufficient medication.

Assessment and monitoring
Pharmacologic therapy
Control of factors contributing to asthma severity
Patient education for a partnership

6 Managing Asthma Exacerbations at Home, in the Emergency Department, and in the Hospital

Home Management: Prompt Treatment Is Key

Educating patients to recognize and treat exacerbations early is the best strategy.

Education and preparation of patients to manage their exacerbations* are essential and should include:

- A written action plan and clear instructions on how to follow it. (See patient handout, “Asthma Action Plan,” and figure 12).
- Instructions on how to recognize signs of worsening asthma and signs that indicate the need to call the doctor or seek emergency care.
- Prompt use of short-acting beta₂-agonists (two puffs every 20 minutes for 1 hour) and, for moderate-to-severe exacerbations, the addition of

* Asthma exacerbations are episodes of progressively worsening shortness of breath, cough, wheezing, chest tightness, or some combination of these symptoms.

oral steroids. Increased therapy should be maintained for several days to stabilize symptoms and peak flow.

- Monitoring the response to the medications.
- Followup with patients to assess overall asthma control, the need to increase long-term-control medications, and the need to remove or withdraw from allergens or irritants that precipitated the exacerbation.

Patients at high risk of asthma-related death

(see box below) **require special attention**—intensive education, monitoring, and care. They should be counseled to seek medical care early during an exacerbation and instructed about when and how to call for an ambulance. Patients with moderate-to-severe persistent asthma or a history of severe exacerbations should have the medication (e.g., steroid tablets or liquid) and equipment (e.g., peak flow meter, compressor-driven nebulizer for young children) for assessing and treating exacerbations at home.

Risk Factors for Death From Asthma

History of Severe Exacerbations

- Past history of sudden severe exacerbations
- Prior intubation for asthma
- Prior admission for asthma to an intensive care unit

Asthma Hospitalizations and Emergency Visits

- ≥ 2 hospitalizations in the past year
- ≥ 3 emergency care visits in the past year
- Hospitalization or emergency visit in past month

Beta₂-Agonist and Oral Steroid Usage

- Use of >2 canisters per month of short-acting inhaled beta₂-agonist
- Current use of oral steroids or recent withdrawal from oral steroids

Complicating Health Problems

- Comorbidity (e.g., cardiovascular diseases or COPD)
- Serious psychiatric disease, including depression, or psychosocial problems
- Illicit drug use

Other Factors

- Poor perception of airflow obstruction or its severity
- Sensitivity to *Alternaria* (an outdoor mold)
- Low socioeconomic status and urban residence

Sources: See references 19, 49-52.

Figure 12.

Management of Asthma Exacerbations: Home Treatment

Give patients the Asthma Action Plan (page 45), which corresponds to this figure.

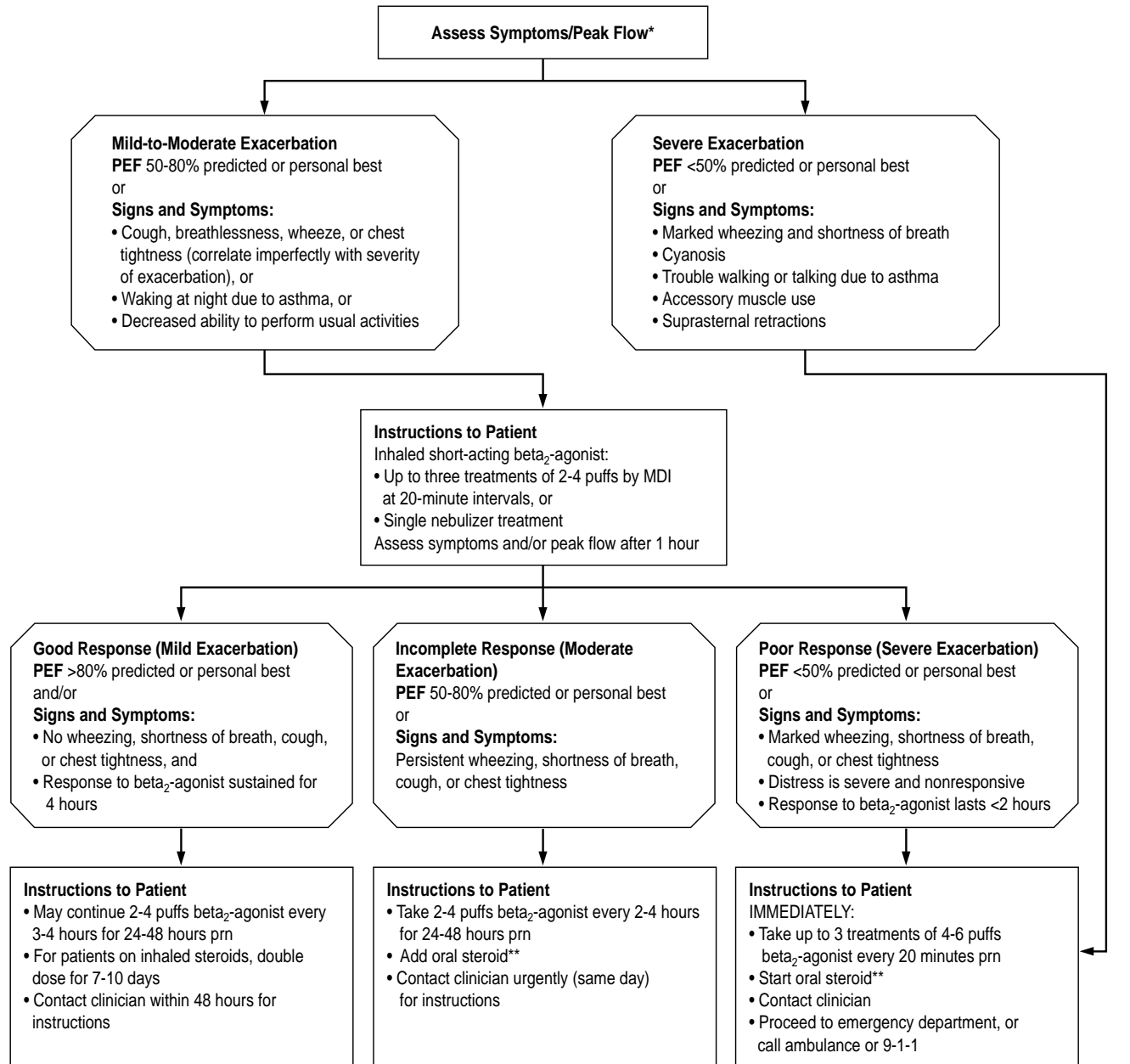

Home Treatment

* Patients at high risk for asthma-related death (see box on page 26) should receive immediate clinical attention after initial treatment. More intensive therapy may be required.

** Oral steroid dosages:

Adult: 40-60 mg, single or 2 divided doses for 3-10 days.

Child: 1-2 mg/kg/day, maximum 60 mg/day, for 3-10 days

Prehospital Emergency Medicine/Ambulance Management

It is recommended that emergency workers administer short-acting inhaled beta₂-agonists and supplemental oxygen to patients who have signs or symptoms of asthma.⁵³ Subcutaneous epinephrine or terbutaline are NOT recommended but can be used if inhaled medication is not available (see dosage information on page 39).

Emergency Department and Hospital Management of Exacerbations

Treat Without Delay

Assess patient's peak flow or FEV₁ and administer medication(s) upon patient's arrival without delay.

After therapy is initiated, obtain a brief, focused history and physical examination pertinent to the exacerbation. Perform a more detailed history, physical, and lab studies only after therapy has started.

The goals for treating asthma exacerbations are rapid reversal of airflow obstruction, reduction in the likelihood of recurrence, and correction of significant hypoxemia. To achieve these goals, the management of asthma exacerbations in the emergency department and hospital (see figure 13 and dosage chart on page 39) includes:

- **Oxygen for most patients** to maintain SaO₂ ≥90 percent (>95 percent in pregnant women, infants, and patients with coexistent heart disease). Monitor oxygen saturation until a significant clinical improvement has occurred.
- **Short-acting inhaled beta₂-agonists every 20 to 30 minutes for three treatments for all patients** (see box on page 30). The onset of action is about 5 minutes. Subsequent therapy depends on response (see figure 13). Subcutaneous beta₂-agonists provide no proven advantage over inhaled medication.

NOTE: Anticholinergics added to albuterol may be considered. Adding high doses of ipratropium bromide (0.5 mg in adults, 0.25 mg in children) to albuterol in a nebulizer has been shown to cause additional bronchodilation in some but not all studies,⁵⁴⁻⁵⁶ particularly in patients with severe airflow obstruction.

- **Oral steroids should be given to most patients**—those with moderate-to-severe exacerbations, patients who fail to respond promptly and completely to an inhaled beta₂-agonist, and patients admitted into the hospital. Oral steroids speed recovery and reduce the likelihood of recurrence. Onset of action is greater than 4 hours.⁵⁷⁻⁵⁹ Often, a 3- to 10-day course of oral steroids at discharge is useful.
 - For patients who take oral steroids long term, give supplemental doses, even if the exacerbation is mild.
 - In infants and children, give oral steroids early in the course of an asthma exacerbation.
 - Oral administration of prednisone is usually preferred to intravenous methylprednisolone because it is less invasive and the effects are equivalent.^{60,61}

Repeat Assessment

The Expert Panel recommends repeat assessments of patients with severe exacerbations after the first dose and the third dose (about 60 to 90 minutes after initiating treatment) of short-acting inhaled beta₂-agonists. Evaluate the patient's subjective response, physical findings, and lung function. Consider arterial blood gas measurement for evaluating arterial carbon dioxide (PCO₂) in patients with suspected hypoventilation, severe distress, or with FEV₁ or peak flow ≤30 percent of predicted after treatment.

Effectiveness of MDI Plus Spacer/Holding Chamber vs. Nebulizer

Equivalent bronchodilation can be achieved by a beta₂-agonist given by MDI with a spacer/holding chamber under the supervision of trained personnel or by nebulizer therapy.⁶²⁻⁶⁴ Continuous administration with a nebulizer may be more effective in children and severely obstructed adults⁶⁵⁻⁶⁸ and patients who have difficulty with an MDI plus spacer/holding chamber.

Figure 13.

Management of Asthma Exacerbations: Emergency Department and Hospital-Based Care

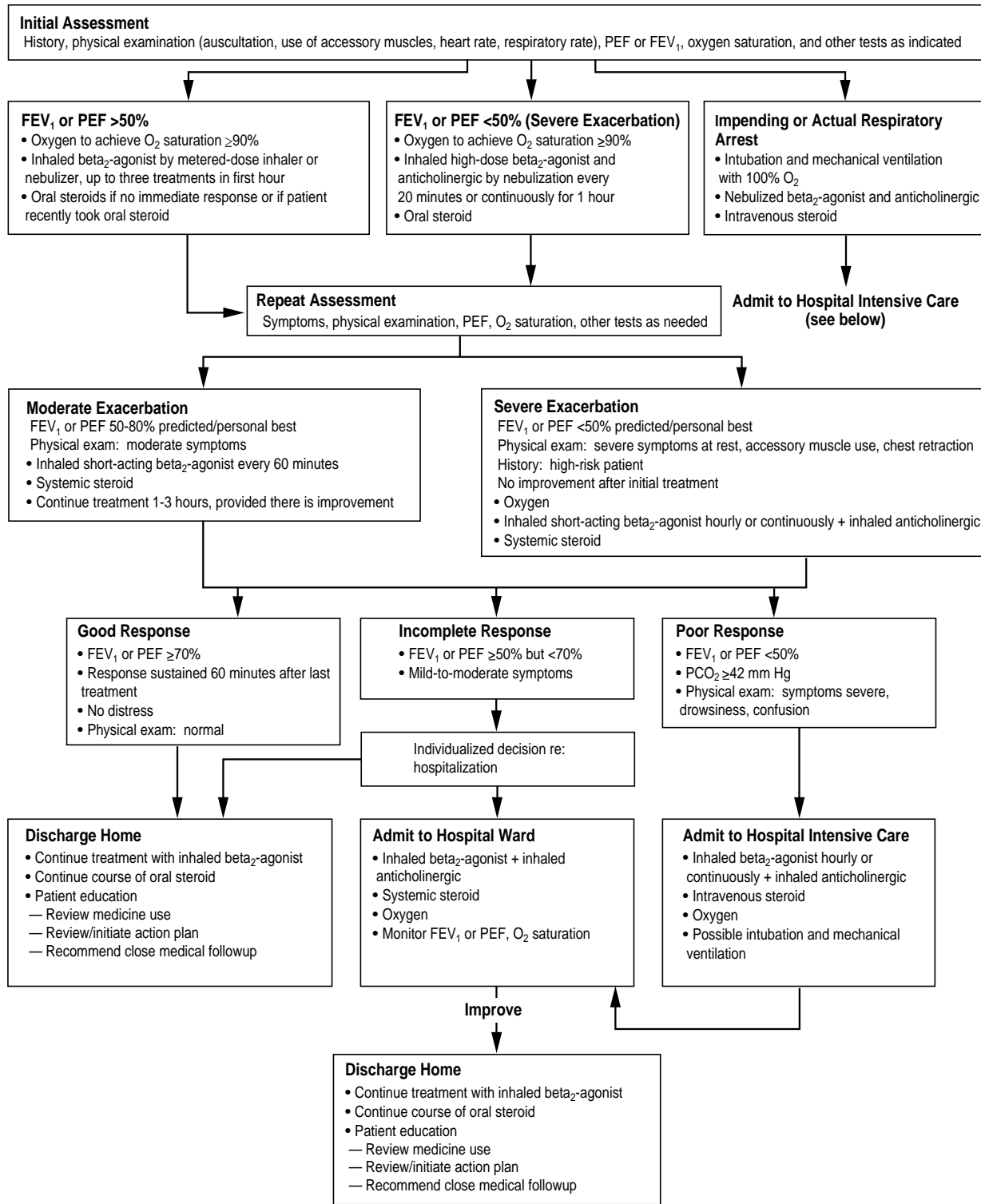

E.D./Hospital Care

Special Considerations for Infants

Infants require special attention due to their greater risk for respiratory failure.

- Use oral steroids early in the episode.
- Monitor oxygen saturation by pulse oximetry. SaO₂ should be >95 percent at sea level.
- Assess infants for signs of serious distress, including use of accessory muscles, paradoxical breathing, cyanosis, a respiratory rate >60, or oxygen saturation <91 percent.
- Assess response to therapy. A lack of response to beta₂-agonist therapy noted by physical exam or oxygen saturation is an indication for hospitalization.

Therapies Not Recommended for Treating Exacerbations

Theophylline/aminophylline is NOT recommended therapy in the emergency department because it appears to provide no additional benefit to short-acting inhaled beta₂-agonists and may produce adverse effects.⁶⁹⁻⁷³ In hospitalized patients, intravenous methylxanthines are not beneficial in children with severe asthma⁷⁴⁻⁷⁶ and their addition remains controversial for adults.^{77,78}

Chest physical therapy and mucolytics are not recommended. Anxiolytic and hypnotic drugs are contraindicated. Antibiotics are NOT recommended for asthma treatment but may be needed for comorbid conditions (e.g., patients with fever and purulent sputum or with evidence of bacterial pneumonia). Aggressive hydration is NOT recommended for older children and adults. Assess fluid status and make appropriate corrections for infants and young children to reduce their risk of dehydration.

Hospital Asthma Care

In general, the principles of care in the hospital are similar to those for care in the emergency department and involve treatment with aerosolized bronchodilators, systemic steroids, oxygen, and frequent assessments (see figure 13). Clinical assessment of respiratory distress and fatigue and objective measurement of airflow (peak flow or FEV₁) and oxygen saturation with pulse oximetry should be performed. Most patients respond well to therapy; however, a small minority will show signs of worsening ventilation.

Signs of impending respiratory failure include declining mental clarity, worsening fatigue, and a PCO₂ of ≥42 mm Hg. Respiratory failure tends to progress rapidly and is hard to reverse. The decision to intubate is based on clinical judgment; however, intubation is best done semi-electively, before the crisis of respiratory arrest. Therefore, the Expert Panel recommends that intubation should not be delayed once it is deemed necessary. Intubation should be performed by physicians with extensive experience in intubation and airway management. Consultation or comanagement by a physician expert in ventilator management is appropriate.

Patient Discharge From the Emergency Department or Hospital

Patients can be discharged from the emergency department and hospital when peak flow or FEV₁ is ≥70 percent of predicted or personal best and symptoms are minimal. Patients should be assessed for discharge on an individual basis if they have a peak flow or FEV₁ of ≥50 but <70 percent of predicted or personal best and mild symptoms. Take into consideration the risk factors for asthma-related death (see box on page 26). Hospitalized patients should have their medications changed to an oral or inhaled regimen and then be observed for 24 hours before discharge.

Before Discharge, Provide Patients With the Following:

- **Sufficient short-acting inhaled beta₂-agonist and oral steroids** to complete the course of therapy or to continue therapy until the followup appointment. Patients given oral steroids should continue taking them for 3 to 10 days. **Patients may be asked to start taking or to increase inhaled steroids** in an attempt to improve the patient's long-term-control regimen.
- **Written and verbal instructions** on when to increase medications or return for care should asthma worsen. The plan provided in the emergency department can be quite simple. Before discharge from the hospital, patients should receive a more complete written action plan (see patient handout, page 45) on when to take their medicines.
- **Training on how to monitor peak flow** should be *provided* in the hospital and *considered* for patients in the emergency department. Also, consider issuing peak flow meters. Patients in both settings should receive instruction on monitoring their symptoms.
- **Training on necessary environmental control measures and inhaler technique, whenever possible.**
- **Referral for a followup medical appointment.** Tell patients from the emergency department to go to a followup appointment within 3 to 5 days or set up an appointment for them. When possible, phone or fax a notice to the patient's physician that the patient came to the emergency department. For both emergency department and hospital patients, emphasize the need for continual, regular care in an outpatient setting. If patients do not have a physician, refer them or arrange a followup visit with a primary care physician, a clinic, or an asthma specialist.

References

- National Heart, Lung, and Blood Institute, National Asthma Education and Prevention Program. *Expert Panel Report 2: Guidelines for the Diagnosis and Management of Asthma*. National Institutes of Health pub no 97-4051. Bethesda, MD, 1997.
- Pappas G, Hadden WC, Kozak LJ, Fisher GF. Potentially avoidable hospitalizations: inequalities in rates between US socioeconomic groups. *Am J Public Health* 1997;87:811-16.
- Friday GA Jr, Khine H, Lin MS, Caliguiri LA. Profile of children requiring emergency treatment for asthma. *Ann Allergy Asthma Immunol* 1997; 78:221-224.
- Hartert TV, Windom HH, Peebles RS Jr, Freidhoff LR, Togias A. Inadequate outpatient medical therapy for patients with asthma admitted to two urban hospitals. *Am J Med* 1996;100:386-394.
- van Essen-Zandvliet EE, Hughes MD, Waalkens HJ, Duiverman EJ, Pocock SJ, Kerrebijn KF. Effects of 22 months of treatment with inhaled steroids and/or beta₂-agonists on lung function, airway responsiveness, and symptoms in children with asthma. *Am Rev Respir Dis* 1992;146:547-54.
- Haahela T, Jarvinen M, Kava T, et al. Comparison of a beta₂-agonist, terbutaline, with an inhaled corticosteroid, budesonide, in newly detected asthma. *N Engl J Med* 1991;325:388-92.
- Jones AH, Langdon CG, Lee PS, et al. Pulmicort Turbuhaler once daily as initial prophylactic therapy for asthma. *Respir Med* 1994;88:293-9.
- Pincus DJ, Szeffler SJ, Ackerson LM, Martin RJ. Chronotherapy of asthma with inhaled steroids: the effect of dosage timing on drug efficacy. *J Allergy Clin Immunol* 1995;95:1172-8.
- Noonan M, Chervinsky P, Busse WW, et al. Fluticasone propionate reduces oral prednisone use while it improves asthma control and quality of life. *Am J Respir Crit Care Med* 1995;152:1467-73.
- Haahela T, Jarvinen M, Kava T, et al. Effects of reducing or discontinuing inhaled budesonide in patients with mild asthma. *N Engl J Med* 1994; 331:700-5.
- Waalkens HJ, Van Essen-Zandvliet EE, Hughes MD, et al. Cessation of long-term treatment with inhaled corticosteroid (budesonide) in children with asthma results in deterioration. *Am Rev Respir Dis* 1993;148:1252-7.
- Dahl R, Lundback E, Malo JL, et al. A dose-ranging study of fluticasone propionate in adult patients with moderate asthma. *Chest* 1993;104:1352-8.
- Fabbri L, Burge PS, Croonenborgh L, et al. on behalf of an International Study Group. Comparison of fluticasone propionate with beclomethasone dipropionate in moderate to severe asthma treated for one year. *Thorax* 1993;48:817-23.
- Gustafsson P, Tsanakas J, Gold M, Primhak R, Radford M, Gillies E. Comparison of the efficacy and safety of inhaled fluticasone 200 mcg/day with inhaled beclomethasone dipropionate 400 mcg/day in mild and moderate asthma. *Arch Dis Child* 1993;69:206-11.
- Jeffery PK, Godfrey RW, Adelroth E, Nelson F, Rogers A, Johansson SA. Effects of treatment on airway inflammation and thickening of basement membrane reticular collagen in asthma. *Am Rev Respir Dis* 1992;145: 890-9.
- Rafferty P, Tucker LG, Frame MH, Fergusson RJ, Biggs BA, Crompton GK. Comparison of budesonide and beclomethasone dipropionate in patients with severe chronic asthma: assessment of relative prednisolone-sparing effects. *Br J Dis Chest* 1985;79:244-50.
- Greening AP, Wind P, Northfield M, Shaw G. Added salmeterol versus higher-dose steroid in asthma patients with symptoms on existing inhaled steroid. *Lancet* 1994;344:219-24.
- Woolcock A, Lundback B, Ringdal N, Jacques LA. Comparison of addition of salmeterol to inhaled steroids with doubling of the dose of inhaled steroid. *Am J Respir Crit Care Med* 1996;153:1481-8.
- Suissa S, Ernst P, Bolvin JF, et al. A cohort analysis of excess mortality in asthma and the use of inhaled beta₂-agonists. *Am J Respir Crit Care Med* 1994;149(3 Pt 1):604-10.
- Drazen JM, Israel E, Boushey HA, et al. Comparison of regularly scheduled with as-needed use of albuterol in mild asthma. *N Engl J Med* 1996;335:841-7.
- Wolthers OD. Long-, intermediate- and short-term growth studies in asthmatic children treated with inhaled glucocorticoids. *Eur Respir J* 1996;9: 821-7.
- Kamada AK, Szeffler SJ, Martin RJ, et al. and the Asthma Clinical Research Network. Issues in the use of inhaled glucocorticoids. *Am J Respir Crit Care Med* 1996;153:1739-48.
- Barnes PJ, Pedersen S. Efficacy and safety of inhaled steroids in asthma. *Am Rev Respir Dis* 1993;148:S1-S26.
- Tinkelman DG, Reed CE, Nelson HS, Offord KP. Aerosol beclomethasone dipropionate compared with theophylline as primary treatment of chronic, mild to moderately severe asthma in children. *Pediatrics* 1993;92:64-77.
- Doull IJM, Freezer NJ, Holgate ST. Growth of pre-pubertal children with mild asthma treated with inhaled beclomethasone dipropionate. *Am J Respir Crit Care Med* 1995;151:1715-9.
- Kemp JP, Dockhorn RJ, Busse WW, Bleecker ER, Van As A. Prolonged effect of inhaled salmeterol against exercise-induced bronchospasm. *Am J Respir Crit Care Med* 1994;150:1612-5.
- Albazzaz MK, Neale MG, Patel KR. Dose-response study of nebulized nedocromil sodium in exercise induced asthma. *Thorax* 1989;44:816-9.
- de Benedictis FM, Tuteri G, Pazzelli P, Bertotto A, Bruni L, Vaccaro R. Cromolyn versus nedocromil: duration of action in exercise-induced asthma in children. *J Allergy Clin Immunol* 1995;96:510-4.
- Woolley M, Anderson SD, Quigley BM. Duration of terbutaline sulfate and cromolyn sodium alone and in combination on exercise-induced asthma. *Chest* 1990;97:39-45.
- Vathenen AS, Knox AJ, Wisniewski A, Tattersfield AE. Effect of inhaled budesonide on bronchial reactivity to histamine, exercise, and eucapnic dry air hyperventilation in patients with asthma. *Thorax* 1991;46:811-6.
- Nastasi KJ, Heinly TL, Blaiss MS. Exercise-induced asthma and the athlete. *J Asthma* 1995;32:249-57.
- Nelson HS, Weber RW. Endocrine aspects of allergic diseases. In: Bierman CW, Pearlman DS, eds. *Allergic Diseases From Infancy to Adulthood*. Philadelphia: WB Saunders, 1988. ch. 15.
- Schatz M, Zeiger RS, Harden KM, et al. The safety of inhaled beta-agonist bronchodilators during pregnancy. *J Allergy Clin Immunol* 1988;82:686-95.
- Federal Register*. 21 CFR Parts 201, 202. 1979;44(124):37434-37467.
- Briggs GG, Freeman RK, Yaffe SJ. *Drugs in Pregnancy and Lactation: A Reference Guide to Fetal and Neonatal Risk*, 2nd ed. Baltimore, MD: Williams & Wilkins, 1986.
- Peroni DG, Boner AL, Vallone G, Antolini I, Warner JO. Effective allergen avoidance at high altitude reduces allergen-induced bronchial hyperresponsiveness. *Am J Respir Crit Care Med* 1994;149(6):1442-6.
- Piacentini GL, Martinati L, Fornari A, et al. Antigen avoidance in a mountain environment: influence on basophil releasability in children with allergic asthma. *J Allergy Clin Immunol* 1993;92(5):644-50.
- Simon HU, Grotzer M, Nikolaizik WH, Blaser K, Schoni MH. High altitude climate therapy reduces peripheral blood T lymphocyte activation, eosinophilia, and bronchial obstruction in children with house-dust mite allergic asthma. *Pediatr Pulmonol* 1994;17(5):304-11.
- Murray AB, Ferguson AC. Dust-free bedrooms in the treatment of asthmatic children with house dust or house dust mite allergy: a controlled trial. *Pediatrics* 1983;71:418-22.

40. Murray AB, Milner RA. The accuracy of features in the clinical history for predicting atopic sensitization to airborne allergens in children. *J Allergy Clin Immunol* 1995;96:588-96.
41. Adinoff AD, Rosloniec DM, McCall LL, Nelson HS. Immediate skin test reactivity to Food and Drug Administration-approved standardized extracts. *J Allergy Clin Immunol* 1990;86:766-74.
42. Abramson MJ, Puy RM, Weiner JM. Is allergen immunotherapy effective in asthma? A meta-analysis of randomized controlled trials. *Am J Respir Crit Care Med* 1995;151:969-74.
43. Reid MJ, Moss RB, Hsu YP, Kwasnicki JM, Commerford TM, Nelson BL. Seasonal asthma in northern California: allergic causes and efficacy of immunotherapy. *J Allergy Clin Immunol* 1986;78:590-600.
44. Malling HJ, Dreborg S, Weeke B. Diagnosis and immunotherapy of mould allergy. V. Clinical efficacy and side effects of immunotherapy with *Cladosporium herbarum*. *Allergy* 1986;41:507-19.
45. Creticos PS, Reed CE, Norman PS, et al. Ragweed immunotherapy in adult asthma. *N Engl J Med* 1996;334(8):501-6.
46. Horst M, Hejjaoui A, Horst V, Michel FB, Bousquet J. Double-blind, placebo-controlled rush immunotherapy with a standardized *Alternaria* extract. *J Allergy Clin Immunol* 1990;85:460-72.
47. American Academy of Allergy and Immunology Board of Directors. Guidelines to minimize the risk from systemic reactions caused by immunotherapy with allergenic extracts. *J Allergy Clin Immunol* 1994;93:811-2.
48. Frew AJ. Injection immunotherapy. British Society for Allergy and Clinical Immunology Working Party. *BMJ* 1993;307:919-23.
49. Kallenbach JM, Frankel AH, Lapinsky SE, et al. Determinants of near fatality in acute severe asthma. *Am J Med* 1993;95:265-72.
50. Rodrigo C, Rodrigo G. Assessment of the patient with acute asthma in the emergency department. A factor analytic study. *Chest* 1993;104:1325-8.
51. Greenberger PA, Miller TP, Lifschultz B. Circumstances surrounding deaths from asthma in Cook County (Chicago) Illinois. *Allergy Proc* 1993;14:321-6.
52. O'Hollaren MT, Yunginger JW, Offord KP, et al. Exposure to an aeroallergen as a possible precipitating factor in respiratory arrest in young patients with asthma. *N Engl J Med* 1991;324:359-63.
53. Fergusson, RJ, Stewart CM, Wathen CG, Moffat R, Crompton GK. Effectiveness of nebulised salbutamol administered in ambulances to patients with acute severe asthma. *Thorax* 1995;50:81-2.
54. Schuh S, Johnson DW, Callahan S, Canny G, Levison H. Efficacy of frequent nebulized ipratropium bromide added to frequent high-dose albuterol therapy in severe childhood asthma. *J Pediatr* 1995;126:639-45.
55. Kelly HW, Murphy S. Corticosteroids for acute, severe asthma. *DICP* 1991;25:72-9.
56. Karpel JP, Schacter EN, Fanta C, et al. A comparison of ipratropium and albuterol vs. albuterol alone for the treatment of acute asthma. *Chest* 1996;110:611-6.
57. Rowe BH, Keller JL, Oxman AD. Effectiveness of steroid therapy in acute exacerbations of asthma: a meta-analysis. *Am J Emerg Med* 1992;10:301-10.
58. Scarfone RJ, Fuchs SM, Nager AL, Shane SA. Controlled trial of oral prednisone in the emergency department treatment of children with acute asthma. *Pediatrics* 1993;2:513-8.
59. Connott GJ, Warde C, Wooler E, Lenney W. Prednisolone and salbutamol in the hospital treatment of acute asthma. *Arch Dis Child* 1994;70:170-3.
60. Harrison BD, Stokes TC, Hart GJ, Vaughan DA, Ali NJ, Robinson AA. Need for intravenous hydrocortisone in addition to oral prednisolone in patients admitted to hospital with severe asthma without ventilatory failure. *Lancet* 1986;1(8474):181-4.
61. Ratto D, Alfaro C, Sipse J, Glovsky MM, Sharma OP. Are intravenous corticosteroids required in status asthmaticus? *JAMA* 1988;260:527-9.
62. Idris AH, McDermott MF, Raucci JC, Morrabel A, McGorray S, Hendeles L. Emergency department treatment of severe asthma. Metered-dose inhaler plus holding chamber is equivalent in effectiveness to nebulizer. *Chest* 1993;103:665-72.
63. Colacone A, Afilalo M, Wolkove N, Kreisman H. A comparison of albuterol administered by metered dose inhaler (and holding chamber) or wet nebulizer in acute asthma. *Chest* 1993;104:835-41.
64. Kerem E, Levison H, Schuh S, et al. Efficacy of albuterol administered by nebulizer versus spacer device in children with acute asthma. *J Pediatr* 1993;123:313-7.
65. Lin RY, Sauter D, Newman T, Sirleaf J, Walters J, Tavakol M. Continuous versus intermittent albuterol nebulization in the treatment of acute asthma. *Ann Emerg Med* 1993;22:1847-53.
66. Rudnitsky GS, Eberlein RS, Schoffstall JM, Mazur JE, Spivey WH. Comparison of intermittent and continuously nebulized albuterol for treatment of asthma in an urban emergency department. *Ann Emerg Med* 1993;22:1842-6.
67. Papo MC, Frank J, Thompson AE. A prospective, randomized study of continuous versus intermittent nebulized albuterol for severe status asthmaticus in children. *Crit Care Med* 1993;21:1479-86.
68. Kelly HW, Murphy S. Beta-adrenergic agonists for acute, severe asthma. *Ann Pharmacother* 1992;26:81-91.
69. Fanta CH, Rossing TH, McFadden ER Jr. Treatment of acute asthma: is combination therapy with sympathomimetics and methylxanthines indicated? *Am J Med* 1986;80:5-10.
70. Rossing TH, Fanta CH, Goldstein DH, Snapper JR, McFadden ER Jr. Emergency therapy of asthma: comparison of the acute effects of parenteral and inhaled sympathomimetics and infused aminophylline. *Am Rev Respir Dis* 1980;122:365-71.
71. Murphy DG, McDermott MF, Rydman RJ, Sloan EP, Zalenski RJ. Aminophylline in the treatment of acute asthma when beta₂-adrenergics and steroids are provided. *Arch Intern Med* 1993;153:1784-88.
72. Rodrigo C, Rodrigo G. Treatment of acute asthma. Lack of therapeutic benefit and increase of the toxicity from aminophylline given in addition to high doses of salbutamol delivered by metered-dose inhaler with a spacer. *Chest* 1994;106:1071-6.
73. Coleridge J, Cameron P, Epstein J, Teichtahl H. Intravenous aminophylline confers no benefit in acute asthma treated with intravenous steroids and inhaled bronchodilators. *Aust N Z J Med* 1993;23:348-54.
74. Strauss RE, Wertheim DL, Bonagura VR, Valacer DJ. Aminophylline therapy does not improve outcome and increases adverse effects in children hospitalized with acute asthmatic exacerbations. *Pediatrics* 1994;93:205-10.
75. Carter E, Cruz M, Chesrown S, Shieh G, Reilly K, Hendeles L. Efficacy of intravenously administered theophylline in children hospitalized with severe asthma. *J Pediatr* 1993;122:470-6.
76. DiGiulio GA, Kerckmar CM, Krug SE, Alpert SE, Marx CM. Hospital treatment of asthma: lack of benefit from theophylline given in addition to nebulized albuterol and intravenously administered corticosteroid. *J Pediatr* 1993;122:464-9.
77. Huang D, O'Brien RG, Harman E, et al. Does aminophylline benefit adults admitted to the hospital for an acute exacerbation of asthma? *Ann Intern Med* 1993;119:1155-60.
78. Self TH, Abou-Shala N, Burns R, et al. Inhaled albuterol and oral prednisone therapy in hospitalized adult asthmatics. Does aminophylline add any benefit? *Chest* 1990;98:1317-21.

Appendices

Dosages for Medications

Usual Dosages for Long-Term-Control Medications	36
Estimated Comparative Daily Dosages for Inhaled Steroids	38
Dosages of Drugs for Asthma Exacerbations in Emergency Medical Care or Hospital	39

Glossary

Asthma Long-Term-Control Medications	40
Asthma Quick-Relief Medications	40

Patient Handouts

What Everyone Should Know About Asthma Control	41
How To Control Things That Make Your Asthma Worse	42
How To Use Your Metered-Dose Inhaler the Right Way	44
Asthma Action Plan	45
School Self-Management Plan	46
How To Use Your Peak Flow Meter	48

Patient Self-Assessment Forms

Patient Self-Assessment Form for Environmental and Other Factors That Can Make Asthma Worse*	50
Patient Self-Assessment Form for Followup Visits*	52

* These questions are examples and do not represent a standardized assessment or diagnostic instrument. The validity and reliability of these questions have not been assessed.

Usual Dosages for Long-Term-Control Medications*

Medication	Dosage Form	Adult Dose	Child Dose	Comments
Inhaled Steroids				
(see Estimated Comparative Daily Dosages for Inhaled Steroids, page 38)				<ul style="list-style-type: none"> ■ Most effective anti-inflammatory currently available.
Oral Steroids				
Methylprednisolone	2, 4, 8, 16, 32 mg tablets	<ul style="list-style-type: none"> ■ 7.5-60 mg daily in a single dose or qod as needed for control 	<ul style="list-style-type: none"> ■ 0.25-2 mg/kg daily in single dose or qod as needed for control 	<ul style="list-style-type: none"> ■ For long-term treatment of severe persistent asthma, administer single dose in a.m. either daily or on alternate days (which may lessen adrenal suppression). One study suggests improved efficacy and no increase in adrenal suppression when administered at 3:00 p.m. ■ Short courses or "bursts" are effective for establishing control when initiating therapy or during a period of gradual deterioration. ■ The burst should be continued until patient achieves 80% of peak flow personal best or symptoms resolve. This usually requires 3-10 days but may require longer. There is no evidence that tapering the dose following improvement prevents relapse.
Prednisolone	5 mg tabs, 5 mg/5 cc, 15 mg/5 cc	<ul style="list-style-type: none"> ■ Short-course "burst": 40-60 mg per day as single or 2 divided doses for 3-10 days 	<ul style="list-style-type: none"> ■ Short course "burst": 1-2 mg/kg/day, maximum 60 mg/day, for 3-10 days 	
Prednisone	1, 2.5, 5, 10, 20, 25 mg tabs; 5 mg/cc, 5 mg/5 cc			
Cromolyn and Nedocromil				
Cromolyn	MDI 1 mg/puff (200 sprays/canister) Nebulizer solution 20 mg/ampule	2-4 puffs tid-qid 1 ampule tid-qid	1-2 puffs tid-qid 1 ampule tid-qid	<ul style="list-style-type: none"> ■ An initial trial in children with mild-to-moderate persistent asthma is often given due to strong safety profile. ■ Can usually see therapeutic effect of cromolyn within 2 weeks; takes 4 to 6 weeks to determine maximum effect. ■ Dose of cromolyn by MDI may be inadequate, so nebulizer may be preferred.
Nedocromil	MDI 1.75 mg/puff (104 sprays/canister)	2-4 puffs bid-qid	1-2 puffs bid-qid	
Long-Acting Bronchodilators				
Salmeterol	Inhaled MDI 21 mcg/puff, 60 or 120 puffs (120 sprays/canister) DPI 50 mcg/blister	2 puffs q 12 hours 1 blister q 12 hours	1-2 puffs q 12 hours 1 blister q 12 hours	<ul style="list-style-type: none"> ■ Should not be used in place of anti-inflammatory therapy. ■ Use with inhaled steroids in step 3. ■ May use one dose nightly for symptoms. ■ Duration of bronchodilation is 12 hours. ■ Should not be used for symptom relief or for exacerbations.
Sustained-release albuterol	Tablet 4 mg tablet	4 mg q 12 hours	0.3-0.6 mg/kg/day, not to exceed 8 mg/day	

Usual Dosages for Long-Term-Control Medications* CONTINUED

Medication	Dosage Form	Adult Dose	Child Dose	Comments
Theophylline	Liquids Sustained-release tablets and capsules	Starting dose 10 mg/kg/day up to 300 mg max; usual max 800 mg/day	Starting dose 10 mg/kg/day; usual max: ■ ≥1 year of age: 16 mg/kg/day ■ <1 year: 0.2 (age in weeks) + 5 = mg/kg/day	<ul style="list-style-type: none"> ■ Adjuvant to inhaled steroids for nocturnal symptoms ■ Alternative, but not preferred, long-term therapy at step 2. ■ Adjust dosage to achieve peak serum concentration of 5-15 mcg/mL at steady-state (at least 48 hours on same dosage). ■ Due to wide interpatient variability in theophylline metabolic clearance, routine serum theophylline level monitoring is important.
Leukotriene Modifiers				
Zafirlukast	20 mg tablet	40 mg daily (1 tablet bid)		<ul style="list-style-type: none"> ■ May be considered at step 2 for patients ≥12 years of age, although their position in therapy is not fully established. ■ For zafirlukast, administration with meals decreases bioavailability; take at least 1 hour before or 2 hours after meals. ■ For patients taking zafirlukast and warfarin, closely monitor prothrombin and adjust warfarin dosage. ■ For zileuton, monitor hepatic enzymes (ALT).
Zileuton	300 mg tablet 600 mg tablet	2,400 mg daily (two 300-mg tablets or one 600-mg tablet, qid)		

NOTE: All chlorofluorocarbon (CFC)-propelled inhalers are being phased out. The new non-CFC products should have similar effectiveness and safety levels as the original product.

* For a list of brand names, see glossary, page 40.

Estimated Comparative Daily Dosages for Inhaled Steroids

Adults

Inhaled Steroid	Low Dose	Medium Dose	High Dose
Beclomethasone dipropionate 42 mcg/puff 84 mcg/puff	168-504 mcg 4-12 puffs—42 mcg 2-6 puffs—84 mcg	504-840 mcg 12-20 puffs—42 mcg 6-10 puffs—84 mcg	>840 mcg >20 puffs—42 mcg >10 puffs—84 mcg
Budesonide DPI 200 mcg/dose	200-400 mcg 1-2 inhalations	400-600 mcg 2-3 inhalations	>600 mcg >3 inhalations
Flunisolide 250 mcg/puff	500-1,000 mcg 2-4 puffs	1,000-2,000 mcg 4-8 puffs	>2,000 mcg >8 puffs
Fluticasone MDI: 44, 110, 220 mcg/puff DPI: 50, 100, 250 mcg/dose	88-264 mcg 2-6 puffs—44 mcg or 2 puffs—110 mcg 2-6 inhalations—50 mcg	264-660 mcg 2-6 puffs—110 mcg 3-6 inhalations—100 mcg	>660 mcg >6 puffs—110 mcg or >3 puffs—220 mcg >6 inhalations—100 mcg or >2 inhalations—250 mcg
Triamcinolone acetonide 100 mcg/puff	400-1,000 mcg 4-10 puffs	1,000-2,000 mcg 10-20 puffs	>2,000 mcg >20 puffs

Children ≤12 years

Inhaled Steroid	Low Dose	Medium Dose	High Dose
Beclomethasone dipropionate 42 mcg/puff 84 mcg/puff	84-336 mcg 2-8 puffs—42 mcg 1-4 puffs—84 mcg	336-672 mcg 8-16 puffs—42 mcg 4-8 puffs—84 mcg	>672 mcg >16 puffs—42 mcg >8 puffs—84 mcg
Budesonide DPI 200 mcg/dose	100-200 mcg	200-400 mcg 1-2 inhalations—200 mcg	>400 mcg >2 inhalations—200 mcg
Flunisolide 250 mcg/puff	500-750 mcg 2-3 puffs	1,000-1,250 mcg 4-5 puffs	>1,250 mcg >5 puffs
Fluticasone MDI: 44, 110, 220 mcg/puff DPI: 50, 100, 250 mcg/dose	88-176 mcg 2-3 puffs—44 mcg 2-4 inhalations—50 mcg	176-440 mcg 4-10 puffs—44 mcg or 2-4 puffs—110 mcg 2-4 inhalations—100 mcg	>440 mcg >4 puffs—110 mcg or >2 puffs—220 mcg >4 inhalations—100 mcg or >2 inhalations—250 mcg
Triamcinolone acetonide 100 mcg/puff	400-800 mcg 4-8 puffs	800-1,200 mcg 8-12 puffs	>1,200 mcg >12 puffs

- Clinician judgment of patient response is essential to appropriate dosing. Once asthma is controlled, medication doses should be carefully titrated to the minimum dose required to maintain control, thus reducing the potential for adverse effect.
- Data from *in vitro* and clinical trials suggest that different inhaled corticosteroid preparations are not equivalent on a per puff or microgram basis. However, few data

directly compare the preparations. The Expert Panel developed recommended dose ranges for different preparations based on available data.

- Inhaled corticosteroid safety data suggest dose ranges for children equivalent to beclomethasone dipropionate 200-400 mcg/day (low dose), 400-800 mcg/day (medium dose), and >800 mcg/day (high dose).

Dosages of Drugs for Asthma Exacerbations in Emergency Medical Care or Hospital*

Medication	Dosages		Comments
	Adults	Children	
Inhaled short-acting beta₂-agonists			
Albuterol Nebulizer solution (5 mg/mL)	2.5-5 mg every 20 min for 3 doses, then 2.5-10 mg every 1-4 hours as needed, or 10-15 mg/hour continuously.	0.15 mg/kg (minimum dose 2.5 mg) every 20 min for 3 doses, then 0.15-0.3 mg/kg up to 10 mg every 1-4 hours as needed, or 0.5 mg/kg/hour by continuous nebulization.	Only selective beta ₂ -agonists are recommended. For optimal delivery, dilute aerosols to minimum of 4 mL at gas flow of 6-8 L/min.
Metered-dose inhaler (90 mcg/puff)	4-8 puffs every 20 min up to 4 hours, then every 1-4 hours as needed.	4-8 puffs every 20 min for 3 doses, then every 1-4 hours as needed.	As effective as nebulized therapy if patient is able to coordinate inhalation maneuver. Use spacer/holding chamber.
Bitolterol and pirbuterol			Have not been studied in severe asthma exacerbations.
Systemic (injected) beta₂-agonists			
Epinephrine 1:1000 (1 mg/mL)	0.3-0.5 mg every 20 min for 3 doses SQ.	0.01 mg/kg up to 0.3-0.5 mg every 20 min for 3 doses SQ.	No proven advantage of systemic therapy over aerosol.
Terbutaline (1 mg/mL)	0.25 mg every 20 min for 3 doses SQ.	0.01 mg/kg every 20 min for 3 doses then every 2-6 hours as needed SQ.	No proven advantage of systemic therapy over aerosol.
Anticholinergics			
Ipratropium bromide Nebulizer solution (0.25 mg/mL)	0.5 mg every 30 min for 3 doses then every 2-4 hours as needed.	0.25 mg every 20 min for 3 doses, then every 2 to 4 hours.	May mix in same nebulizer with albuterol. Should not be used as first-line therapy; should be added to beta ₂ -agonist therapy. Dose delivered from MDI is low and has not been studied in asthma exacerbations.
Metered-dose inhaler (18 mcg/puff)	4-8 puffs as needed.	4-8 puffs as needed.	
Steroids			
Prednisone Methylprednisolone Prednisolone	120-180 mg/day in 3 or 4 divided doses for 48 hours, then 60-80 mg/day until PEF reaches 70% of predicted or personal best.	1 mg/kg every 6 hours for 48 hours then 1-2 mg/kg/day (maximum = 60 mg/day) in 2 divided doses until PEF 70% of predicted or personal best.	Adult "burst" at discharge: 40-60 mg in single or 2 divided doses for 3-10 days. Child "burst" at discharge: 1-2 mg/kg/ day, maximum 60 mg/day for 3-10 days.

* For a list of brand names, see glossary page 40.

Glossary*

Asthma Long-Term-Control Medications

Generic name	Brand name
Corticosteroids: Inhaled	
beclomethasone	Beclovent® Vanceril®, Vanceril®—Double Strength
budesonide	Pulmicort Turbuhaler®
flunisolide	AeroBid®, AeroBid-M®
fluticasone	Flovent®
triamcinolone	Azmacort®

Cromolyn and Nedocromil: Inhaled

cromolyn sodium	Intal®
nedocromil sodium	Tilade®

Leukotriene Modifiers: Oral

zafirlukast	Accolate®
zileuton	Zyflo®

Long-Acting Beta₂-Agonists

salmeterol (inhaled)	Serevent®
albuterol (extended release)	Volmax® Proventil Repetabs®

Theophylline: Oral

Aerolate® III
Aerolate® JR
Aerolate® SR
Choledyl® SA
Elixophyllin®
Quibron®-T
Quibron®-T/SR
Slo-bid®
Slo-Phyllin®
Theo-24®
Theochron®
Theo-Dur®
Theolair®
Theolair®-SR
T-Phyl®
Uni-Dur®
Uniphyll®

Asthma Quick-Relief Medications

Generic name	Brand name
Short-Acting Beta₂-Agonists**: Inhaled	
albuterol	Airet® Proventil® Proventil HFA® Ventolin® Ventolin® Rotacaps
bitolterol	Tornalate®
pirbuterol	Maxair®
terbutaline	Brethaire® Brethine® (tablet only) Bricanyl® (tablet only)

** This list does not include metaproterenol, which is not recommended for relief of acute bronchospasm due to its potential for excessive cardiac stimulation, especially in high doses.

Anticholinergics: Inhaled

ipratropium bromide	Atrovent®
---------------------	-----------

Corticosteroids: Oral

methylprednisolone	Medrol®
prednisone	Prednisone Deltasone® Orasone® Liquid Pred® Prednisone Intenol®
prednisolone	Prelone® Pediapred®

* This glossary is a complete list of brand names associated with the appropriate generic names of asthma medications, as listed in the United States Pharmacopeial Convention, Inc., *Approved Drug Products and Legal Requirements*, Volume III, 17th edition, 1997, and the USP DI *Drug Information for Health Care Professionals*, Volume I, 17th edition, 1997. This list does not constitute an endorsement of these products by the National Heart, Lung, and Blood Institute.

WHAT EVERYONE SHOULD KNOW ABOUT ASTHMA CONTROL

You will learn to take care of your asthma over time. For now, you will be off to a good start if you know just five key things. These five things should guide your efforts to take care of your asthma.

Asthma can be managed so that you can live a normal life.

Your asthma should not keep you from doing what you want. It should not keep you from going to work or school. If it does, talk to your doctor about your treatment.

Asthma is a disease that makes the airways in your lungs inflamed.

This means your airways are swollen and sensitive. The swelling is there all of the time, even when you feel just fine. The swelling can be controlled with medicine and by staying away from things that bother your airways.

Many things in your home, school, work, and other places can cause asthma attacks.

An asthma attack occurs when your airways narrow, making it harder to breathe. Asthma attacks are sometimes called flare-ups, exacerbations, or episodes.

Things in the air that you are allergic to (like pollen) can cause an asthma attack. So can things that bother your airways like tobacco smoke. You can learn to stay away from the things that cause you to have asthma attacks.

Asthma needs to be watched and cared for over a very long time.

Asthma cannot be cured, but it can be treated. You can become free of symptoms all or most of the time. But your asthma does NOT go away when your symptoms go away. You will need to keep taking care of your asthma.

Also, over the years your asthma may change. Your asthma could get worse so you need more medicine. That's why you need to keep in touch with your doctor.

Asthma can be controlled when you manage your asthma and work with your doctor.

You play a big role in taking care of your asthma with your doctor's help. Your job is to:

- Take your medicines as your doctor suggests,
- Watch for signs that your asthma is getting worse and act quickly to stop the attack,
- Stay away from things that can bother your asthma,
- Ask your doctor about any concerns you have about your asthma, and
- See your doctor at least every 6 months.

When you do these things, you will gain—and keep—control of your asthma.

HOW TO CONTROL THINGS THAT MAKE YOUR ASTHMA WORSE

You can help prevent asthma attacks by staying away from things that make your asthma worse. This guide suggests many ways to help you do this.

You need to find out what makes your asthma worse. Some things that make asthma worse for some people are not a problem for others. You do not need to do all of the things listed in this guide.

Look at the things listed in dark print below. Put a check next to the ones that you know make your asthma worse. Ask your doctor to help you find out what else makes your asthma worse. Then, decide with your doctor what steps you will take. Start with the things in your bedroom that bother your asthma. Try something simple first.

Tobacco Smoke

- If you smoke, ask your doctor for ways to help you quit. Ask family members to quit smoking, too.
- Do not allow smoking in your home or around you.
- Be sure no one smokes at a child's day care center.

Dust Mites

Many people with asthma are allergic to dust mites. Dust mites are like tiny "bugs" you cannot see that live in cloth or carpet.

Things that will help the most:

- Encase your mattress in a special dust-proof cover.*
- Encase your pillow in a special dust-proof cover* or wash the pillow each week in hot water. Water must be hotter than 130°F to kill the mites.
- Wash the sheets and blankets on your bed each week in hot water.

Other things that can help:

- Reduce indoor humidity to less than 50 percent. Dehumidifiers or central air conditioners can do this.
- Try not to sleep or lie on cloth-covered cushions or furniture.
- Remove carpets from your bedroom and those laid on concrete, if you can.
- Keep stuffed toys out of the bed or wash the toys weekly in hot water.

Animal Dander

Some people are allergic to the flakes of skin or dried saliva from animals with fur or feathers.

The best thing to do:

- Keep furred or feathered pets out of your home.

If you can't keep the pet outdoors, then:

- Keep the pet out of your bedroom and keep the bedroom door closed.
- Cover the air vents in your bedroom with heavy material to filter the air.*
- Remove carpets and furniture covered with cloth from your home. If that is not possible, keep the pet out of the rooms where these are.

Cockroach

Many people with asthma are allergic to the dried droppings and remains of cockroaches.

- Keep all food out of your bedroom.
- Keep food and garbage in closed containers (never leave food out).
- Use poison baits, powders, gels, or paste (for example, boric acid). You can also use traps.
- If a spray is used to kill roaches, stay out of the room until the odor goes away.

Vacuum Cleaning

- Try to get someone else to vacuum for you once or twice a week, if you can. Stay out of rooms while they are being vacuumed and for a short while afterward.
- If you vacuum, use a dust mask (from a hardware store), a double-layered or micro filter vacuum cleaner bag,* or a vacuum cleaner with a HEPA filter.*

Indoor Mold

- Fix leaky faucets, pipes, or other sources of water.
- Clean moldy surfaces with a cleaner that has bleach in it.

Pollen and Outdoor Mold

What to do during your allergy season (when pollen or mold spore counts are high):

- Try to keep your windows closed.
- Stay indoors with windows closed during the midday and afternoon, if you can. Pollen and some mold spore counts are highest at that time.
- Ask your doctor whether you need to take or increase anti-inflammatory medicine before your allergy season starts.

Smoke, Strong Odors, and Sprays

- If possible, do not use a wood-burning stove, kerosene heater, or fireplace.
- Try to stay away from strong odors and sprays, such as perfume, talcum powder, hair spray, and paints.

Exercise, Sports, Work, or Play

- You should be able to be active without symptoms. See your doctor if you have asthma symptoms when you are active—like when you exercise, do sports, play, or work hard.
- Ask your doctor about taking medicine before you exercise to prevent symptoms.
- Warm up for about 6 to 10 minutes before you exercise.
- Try not to work or play hard outside when the air pollution or pollen levels (if you are allergic to the pollen) are high.

Other Things That Can Make Asthma Worse

- Flu:** Get a flu shot.
- Sulfites in foods:** Do not drink beer or wine or eat shrimp, dried fruit, or processed potatoes if they cause asthma symptoms.
- Cold air:** Cover your nose and mouth with a scarf on cold or windy days.
- Other medicines:** Tell your doctor about all the medicines you may take. Include cold medicines, aspirin, and even eye drops.

*To find out where to get products mentioned in this guide, call:

Asthma and Allergy Foundation of America
(800-727-8462)

Allergy and Asthma Network/Mothers of

Asthmatics, Inc. (800-878-4403)

American Academy of Allergy, Asthma, and Immunology
(800-822-2762)

National Jewish Medical and Research Center

HOW TO USE YOUR METERED-DOSE INHALER THE RIGHT WAY

Using an inhaler seems simple, but most patients do not use it the right way. When you use your inhaler the wrong way, less medicine gets to your lungs. (Your doctor may give you other types of inhalers.)

For the next 2 weeks, read these steps aloud as you do them or ask someone to read them to you. Ask your doctor or nurse to check how well you are using your inhaler.

Use your inhaler in one of the three ways pictured below (A or B are best, but C can be used if you have trouble with A and B).

Steps for Using Your Inhaler

- | | |
|-------------------|--|
| Getting ready | 1. Take off the cap and shake the inhaler.
2. Breathe out all the way.
3. Hold your inhaler the way your doctor said (A, B, or C below). |
| Breathe in slowly | 4. As you start breathing in slowly through your mouth, press down on the inhaler one time. (If you use a holding chamber, first press down on the inhaler. Within 5 seconds, begin to breathe in slowly.)
5. Keep breathing in slowly , as deeply as you can. |
| Hold your breath | 6. Hold your breath as you count to 10 slowly, if you can.
7. For inhaled quick-relief medicine (beta ₂ -agonists), wait about 1 minute between puffs. There is no need to wait between puffs for other medicines. |

- A. Hold inhaler 1 to 2 inches in front of your mouth (about the width of two fingers).

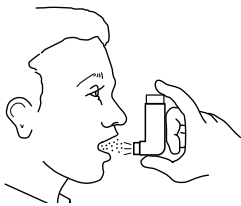

- B. Use a spacer/holding chamber. These come in many shapes and can be useful to any patient.

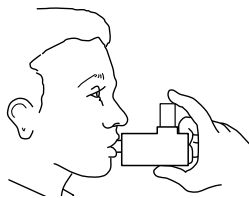

- C. Put the inhaler in your mouth. Do not use for steroids.

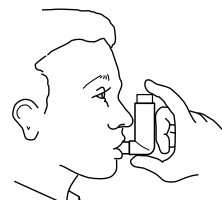

Clean Your Inhaler as Needed

Look at the hole where the medicine sprays out from your inhaler. If you see “powder” in or around the hole, clean the inhaler. Remove the metal canister from the L-shaped plastic mouthpiece. Rinse only the mouthpiece and cap in warm water. Let them dry overnight. In the morning, put the canister back inside. Put the cap on.

Know When To Replace Your Inhaler

For medicines you take each day (an example):

Say your new canister has 200 puffs (number of puffs is listed on canister) and you are told to take 8 puffs per day.

$$8 \text{ puffs per day } \overline{) 200 \text{ puffs in canister}} \quad \begin{array}{r} 25 \text{ days} \\ \hline \end{array}$$

So this canister will last 25 days. If you started using this inhaler on May 1, replace it on or before May 25.

You can write the date on your canister.

For quick-relief medicine take as needed and count each puff.

Do not put your canister in water to see if it is empty. This does not work.

Doctor's Phone Number _____ Hospital/Emergency Room Phone Number _____

National Asthma Education and Prevention Program; National Heart, Lung, and Blood Institute; NIH Publication No. 97-4053

GREEN ZONE: Doing Well

- No cough, wheeze, chest tightness, or shortness of breath during the day or night
- Can do usual activities

And, if a peak flow meter is used,

Peak flow: more than _____
(80% or more of my best peak flow)

My best peak flow is: _____

Take These Long-Term-Control Medicines Each Day (include an anti-inflammatory)

Medicine	How much to take	When to take it

Before exercise

- _____ 2 or 4 puffs 5 to 60 minutes before exercise

YELLOW ZONE: Asthma Is Getting Worse

- Cough, wheeze, chest tightness, or shortness of breath, or
- Waking at night due to asthma, or
- Can do some, but not all, usual activities

-Or-

Peak flow: _____ to _____
(50% - 80% of my best peak flow)



Add: Quick-Relief Medicine – and keep taking your GREEN ZONE medicine

- _____ 2 or 4 puffs, every 20 minutes for up to 1 hour
(short-acting beta₂-agonist) Nebulizer, once



If your symptoms (and peak flow, if used) return to GREEN ZONE after 1 hour of above treatment:

- Take the quick-relief medicine every 4 hours for 1 to 2 days.
- Double the dose of your inhaled steroid for _____ (7-10) days.

-Or-

If your symptoms (and peak flow, if used) do not return to GREEN ZONE after 1 hour of above treatment:

- Take: _____ 2 or 4 puffs or Nebulizer
(short-acting beta₂-agonist)
- Add: _____ mg. per day For _____ (3-10) days
(oral steroid)
- Call the doctor before/ within _____ hours after taking the oral steroid.

RED ZONE: Medical Alert!

- Very short of breath, or
- Quick-relief medicines have not helped, or
- Cannot do usual activities, or
- Symptoms are same or get worse after 24 hours in Yellow Zone

-Or-

Peak flow: less than _____
(50% of my best peak flow)

Take this medicine:

- _____ 4 or 6 puffs or Nebulizer
(short-acting beta₂-agonist)
- _____ mg.
(oral steroid)

Then call your doctor NOW. Go to the hospital or call for an ambulance if:

- You are still in the red zone after 15 minutes AND
- You have not reached your doctor.

DANGER SIGNS

- Trouble walking and talking due to shortness of breath
- Lips or fingernails are blue



- Take 4 or 6 puffs of your quick-relief medicine AND
- Go to the hospital or call for an ambulance (_____) NOW!

SCHOOL SELF-MANAGEMENT PLAN



Asthma and Allergy
Foundation of America
1125 15th St., N.W., Suite 502
Washington, DC 20005

STUDENT ASTHMA ACTION CARD



Name: _____ Grade: _____ Age: _____

Teacher: _____ Room: _____

Parent/Guardian Name: _____ Ph: (H) _____

Address: _____ Ph: (W) _____

Parent/Guardian Name: _____ Ph: (H) _____

Address: _____ Ph: (W) _____

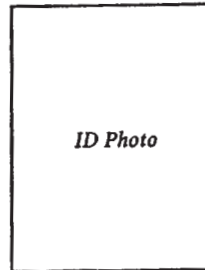

Emergency Phone Contact #1 _____
Name Relationship Phone

Emergency Phone Contact #2 _____
Name Relationship Phone

Physician Student Sees for Asthma: _____ Ph: _____

Other Physician: _____ Ph: _____

DAILY ASTHMA MANAGEMENT PLAN

• Identify the things which start an asthma episode (Check each that applies to the student.)

- Exercise
- Respiratory infections
- Change in temperature
- Animals
- Food _____
- Strong odors or fumes
- Chalk dust
- Carpets in the room
- Pollens
- Molds
- Other _____

Comments _____

• Control of School Environment

(List any environmental control measures, pre-medications, and/or dietary restrictions that the student needs to prevent an asthma episode.)

• Peak Flow Monitoring

Personal Best Peak Flow number: _____

Monitoring Times: _____

• Daily Medication Plan

	Name	Amount	When to Use
1.	_____	_____	_____
2.	_____	_____	_____
3.	_____	_____	_____
4.	_____	_____	_____

SCHOOL SELF-MANAGEMENT PLAN (CONTINUED)

EMERGENCY PLAN

Emergency action is necessary when the student has symptoms such as _____, _____, _____, _____ or has a peak flow reading of _____.

• **Steps to take during an asthma episode:**

1. Give medications as listed below.
2. Have student return to classroom if _____

3. Contact parent if _____
4. Seek emergency medical care if the student has any of the following:
 - ✓ No improvement 15-20 minutes after initial treatment with medication and a relative cannot be reached.
 - ✓ Peak flow of _____
 - ✓ Hard time breathing with:
 - Chest and neck pulled in with breathing
 - Child is hunched over
 - Child is struggling to breathe
 - ✓ Trouble walking or talking
 - ✓ Stops playing and can't start activity again
 - ✓ Lips or fingernails are gray or blue



***IF THIS HAPPENS, GET
EMERGENCY HELP NOW!***

• **Emergency Asthma Medications**

	Name	Amount	When to Use
1.	_____	_____	_____
2.	_____	_____	_____
3.	_____	_____	_____
4.	_____	_____	_____

COMMENTS / SPECIAL INSTRUCTIONS

FOR INHALED MEDICATIONS

- I have instructed _____ in the proper way to use his/her medications. It is my professional opinion that _____ should be allowed to carry and use that medication by him/herself.
- It is my professional opinion that _____ should not carry his/her inhaled medication by him/herself.

Physician Signature

Date

Parent Signature

Date

HOW TO USE YOUR PEAK FLOW METER

A peak flow meter helps you check how well your asthma is controlled. Peak flow meters are most helpful for people with moderate or severe asthma.

This guide will tell you (1) how to find your personal best peak flow number, (2) how to use your personal best number to set your peak flow zones, (3) how to take your peak flow, and (4) when to take your peak flow to check your asthma each day.

Starting Out: Find Your Personal Best Peak Flow Number

To find your personal best peak flow number, take your peak flow each day for 2 to 3 weeks. Your asthma should be under good control during this time. Take your peak flow as close to the times listed below as you can. (These times for taking your peak flow are only for finding your personal best peak flow. To check your asthma

each day, you will take your peak flow in the morning. This is discussed on the next page.)

- Between noon and 2:00 p.m. each day.
- Each time you take your quick-relief medicine to relieve symptoms. (Measure your peak flow after you take your medicine.)

- Any other time your doctor suggests.

Write down the number you get for each peak flow reading. The highest peak flow number you had during the 2 to 3 weeks is your personal best.

Your personal best can change over time. Ask your doctor when to check for a new personal best.

Your Peak Flow Zones

Your peak flow zones are based on your personal best peak flow number. The zones will help you check your asthma and take the right actions to keep it controlled. The colors used with each zone come from the traffic light.

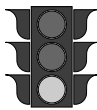

Green Zone (80 to 100 percent of your personal best) signals **good control**. Take your usual daily long-term-control medicines, if you take any. Keep taking these medicines even when you are in the yellow or red zones.

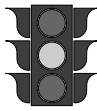

Yellow Zone (50 to 79 percent of your personal best) signals **caution: your asthma is getting worse**. Add quick-relief medicines. You might need to increase other asthma medicines as directed by your doctor.

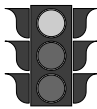

Red Zone (below 50 percent of your personal best) signals **medical alert!** Add or increase quick-relief medicines and call your doctor now.

Ask your doctor to write an action plan for you that tells you:

- The peak flow numbers for your green, yellow, and red zones. Mark the zones on your peak flow meter with colored tape or a marker.
- The medicines you should take while in each peak flow zone.

How To Take Your Peak Flow

1. Move the marker to the bottom of the numbered scale.
2. Stand up or sit up straight.
3. Take a deep breath. Fill your lungs all the way.
4. Hold your breath while you place the mouthpiece in your mouth, between your teeth. Close your lips around it. Do **not** put your tongue inside the hole.
5. Blow out as hard and fast as you can. Your peak flow meter will measure how fast you can blow out air.
6. Write down the number you get. But if you cough or make a mistake, do not write down the number. Do it over again.
7. Repeat steps 1 through 6 two more times. Write down the highest of the three numbers. This is your peak flow number.
8. Check to see which peak flow zone your peak flow number is in. Do the actions your doctor told you to do while in that zone.

Your doctor may ask you to write down your peak flow numbers each day. You can do this on a calendar or other paper. This will help you and your doctor see how your asthma is doing over time.

Checking Your Asthma: When To Use Your Peak Flow Meter

- **Every morning** when you wake up, *before* you take medicine. Make this part of your daily routine.
- **When you are having asthma symptoms or an attack.** And after taking medicine for the attack. This can tell you how bad your asthma attack is and whether your medicine is working.
- Any other time your doctor suggests.

If you use more than one peak flow meter (such as at home and at school), be sure that both meters are the same brand.

Bring to Each of Your Doctor's Visits:

- Your peak flow meter.
- Your peak flow numbers if you have written them down each day.

Also, ask your doctor or nurse to check how you use your peak flow meter—just to be sure you are doing it right.

PATIENT SELF-ASSESSMENT FORM FOR ENVIRONMENTAL AND OTHER FACTORS THAT CAN MAKE ASTHMA WORSE

Patient Name: _____

Date: _____

Do you cough, wheeze, have chest tightness, or feel short of breath year-round? (If no, go to next question)..... No ____ Yes ____

If yes:

- Are there **pets** or animals in your home, school, or day care? No ____ Yes ____
- Is there moisture or **dampness** in any room of your home? No ____ Yes ____
- Have you seen **mold** or smelled musty odors any place in your home? No ____ Yes ____
- Have you seen **cockroaches** in your home? No ____ Yes ____
- Do you use a **humidifier** or swamp cooler in your home? No ____ Yes ____

Does your coughing, wheezing, chest tightness, or shortness of breath get worse at certain times of the year? (If no, go to next question) No ____ Yes ____

If yes:

Do your symptoms get worse in the:

- Early spring? (Trees) No ____ Yes ____
- Late spring? (Grasses) No ____ Yes ____
- Late summer to autumn? (Weeds) No ____ Yes ____
- Summer and fall? (*Alternaria*, *Cladosporium*) No ____ Yes ____

Do you **smoke**? No ____ Yes ____

Does anyone smoke at home, work, or day care? No ____ Yes ____

Is a **wood-burning stove or fireplace** used in your home? No ____ Yes ____

Are **kerosene, oil, or gas stoves or heaters** used without vents in your home?..... No ____ Yes ____

Are you exposed to **fumes or odors** from cleaning agents, sprays, or other chemicals? No ____ Yes ____

Do you cough or wheeze during the week, but not on weekends when away from **work or school**? No ____ Yes ____

Do your eyes and nose get irritated soon after you get to work or school?..... No ____

Do your coworkers or classmates have symptoms like yours?..... No ____ Yes ____

Are isocyanates, plant or animal products, smoke, gases, or fumes used where you work? No ____ Yes ____

Is it cold, hot, dusty, or humid where you work? No ____ Yes ____

Do you have a **stuffy nose** or postnasal drip, either at certain times of the year or year-round? No ____ Yes ____

Do you sneeze often or have itchy, watery eyes? No ____ Yes ____

Do you have **heartburn**? No ____ Yes ____

Does food sometimes come up into your throat? No ____ Yes ____

Have you had coughing, wheezing, or shortness of breath at night in the past 4 weeks? No ____ Yes ____

Does your infant vomit then cough or have wheezy cough at night? No ____ Yes ____

Are these symptoms worse after feeding? No ____ Yes ____

Have you had wheezing, coughing, or shortness of breath **after eating** shrimp, dried fruit, or canned or processed potatoes? No ____ Yes ____

After drinking beer or wine? No ____ Yes ____

Are you taking any prescription medicines or over-the-counter **medicines**? No ____ Yes ____

If yes, which ones? _____

Do you use eye drops? No ____ Yes ____

Do you use any medicines that contain beta-blockers (e.g., blood pressure medicine)? No ____ Yes ____

Do you ever take aspirin or other nonsteroidal anti-inflammatory drugs (like ibuprofen)? No ____ Yes ____

Have you ever had coughing, wheezing, chest tightness, or shortness of breath after taking any medication? No ____ Yes ____

Do you cough, wheeze, have chest tightness, or feel short of breath during or after **exercising**? No ____ Yes ____

PATIENT SELF-ASSESSMENT FORM FOR FOLLOWUP VISITS

Patient Name: _____

Date: _____

Please answer the questions below in the space provided on the right.

Since your last visit:

1. Has your asthma been any worse? No ____ Yes ____
 2. Have there been any changes in your home, work, or school environment (such as a new pet, someone smoking)? No ____ Yes ____
 3. Have you had any times when your symptoms were a lot worse than usual? No ____ Yes ____
 4. Has your asthma caused you to miss work or school or reduce or change your activities? No ____ Yes ____
 5. Have you missed any regular doses of your medicines for any reason? No ____ Yes ____
 6. Have your medications caused you any problems? (shakiness, nervousness, bad taste, sore throat, cough, upset stomach) No ____ Yes ____
 7. Have you had any emergency room visits or hospital stays for asthma? No ____ Yes ____
 8. Has the cost of your asthma treatment kept you from getting the medicine or care you need for your asthma? No ____ Yes ____
-

In the past 2 weeks,

9. Have you had a cough, wheezing, shortness of breath, or chest tightness during:
 - the day No ____ Yes ____
 - night No ____ Yes ____
 - exercise or play? No ____ Yes ____
10. (If you use a peak flow meter) Did your peak flow go below 80 percent of your personal best? No ____ Yes ____
11. How many days have you used your inhaled quick-relief medicine? Number of days ____
12. Have you been satisfied with the way your asthma has been? No ____ Yes ____
13. What are some concerns or questions you would like us to address at this visit?

For staff use.

- Peak Flow Technique
- MDI Technique
- Reviewed Action Plan: Daily meds Emergency meds

Discrimination Prohibited: Under provisions of applicable public laws enacted by Congress since 1964, no person in the United States shall, on the grounds of race, color, national origin, handicap, or age, be excluded from participation in, be denied the benefits of, or be subjected to discrimination under any program or activity (or, on the basis of sex, with respect to any education program or activity) receiving Federal financial assistance.

In addition, Executive Order 11141 prohibits discrimination on the basis of age by contractors and subcontractors in the performance of Federal contracts, and Executive Order 11246 states that no federally funded contractor may discriminate against any employee or applicant for employment because of race, color, religion, sex, or national origin. Therefore, the National

U.S. DEPARTMENT OF HEALTH AND
HUMAN SERVICES

Public Health Service
National Institutes of Health
National Heart, Lung, and Blood Institute

NIH Publication No. 97-4053
October 1997